

# 4499 RESTRAINT LUG

CAST DUCTILE IRON  
PRICE INFORMATION

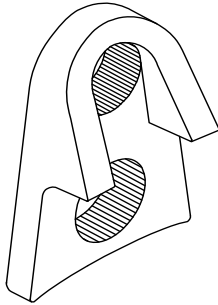

**SIZES AVAILABLE:**  
One Size only.

**USE:**  
**ROBAR 4499** Restraint Lugs are designed for use on Mechanical Joint Fittings to prevent pipe pull-out.

**Material:** Cast Ductile Iron (ASTM A536)

Robar Product No.	PRICE
4499	\$ 6.97

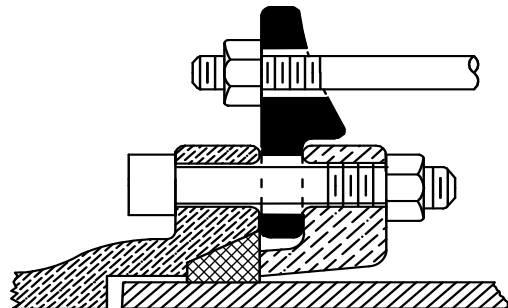
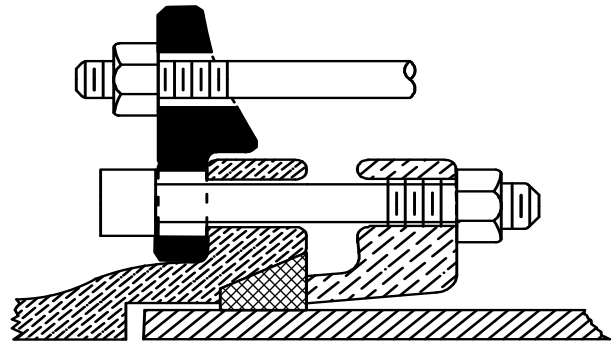

**ROBAR INDUSTRIES LTD.**

**BC**

Phone (604) 591-8811 / 1-800-663-6553  
 Fax (604) 591-5288  
 Email: waterworks@robarindustries.com  
 Web: www.robarindustries.com

**LES PRODUITS INDUSTRIELS ROBAR INC.**

**QUEBEC**

Phone (450) 641-9525 / 1-800-315-9525  
 Fax (450) 641-4894