

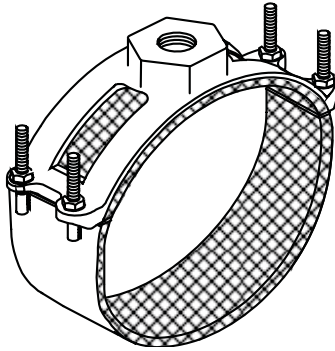

2786 SERVICE SADDLES

CAST BRONZE
PRICE INFORMATION



Sizes Available: 4" - 20" Nominal Pipe OD
Outlets from 3/4" - 2" in AWWA taper (CC) or female iron pipe thread (IP)
Fits Steel (IPS), Ductile Iron and Cast Iron Pipe

Use:
ROBAR 2786 Isolating Saddle are used to electrically isolate an outlet or service line from a main distribution line. Primarily used in cathodically protected systems or to separate dissimilar metals. Waterworks Bronze and Passivated T-304 stainless steel are "noble" materials which are closely related to each other near the top of the Galvanic Scale or corrosion resistance. Unlike pairs of widely dissimilar metals, they will both exhibit long life in most "hot" soil environments.

Material Specification:

Saddle Body: Waterworks Bronze (ASTM B62 and AWWA C-800)
Gaskets: SBR (BUNA-S) Rubber Isolating Compound
Strap & Armor: T-304 Stainless Steel, fully passivated
Fasteners: 1/2" NC T-304 Stainless Steel studs, rolled threads

Nominal Pipe Size	Working Range		List Price
	Low	High*	
4"	4.50	4.80	\$ 359.32
6"	6.60	7.40	\$ 369.82
8"	8.60	9.40	\$ 381.80
10"	10.70	11.50	\$ 409.32
12"	12.70	13.50	\$ 425.15
14"	13.80	14.40	\$ 515.10
	15.20	16.00	\$ 515.10
16"	17.20	18.00	\$ 567.27
18"	19.20	20.00	\$ 593.79
20"	20.80	21.90	\$ 626.95

HOW TO ORDER:

Determine the product number (2786), the high limit of range (see above table), outlet size and outlet thread, and then use the appropriate ordering code as shown in the example.

2786 - 7.40" x 3/4" CC
ie. - 2786 - 7.40 x 3/4CC

Note: The 2786 is designed to be installed with a maximum torque of 45 ft. lbs.
* The high limit of the range is used in the ordering code

ROBAR INDUSTRIES LTD.

BC Phone (604) 591-8811 / 1-800-663-6553
Fax (604) 591-5288
Email: waterworks@robarindustries.com

LES PRODUITS INDUSTRIELS ROBAR INC.

QUEBEC Phone (450) 441-7525 / 1-800-315-9525
Fax (450) 441-4894
Web: www.Robarindustries.com