

# 1406 CAST DUCTILE IRON COUPLINGS

STRAIGHT & TRANSITION  
PRICE INFORMATION

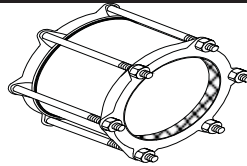

Nom Pipe Size	First End				By X	Second End				MAX. Press. (LBS/IN)	Fasteners No. Dia x Length	Sleeve Length (IN.)	List Price
	Range					Range							
	Low	Pipe OD Actual	High*	End Code		Low	Pipe OD Actual	High*	End Code				
2	2.35	2.38	2.5	D3	x	2.35	2.38	2.5	D3	300	2 5/8 x 8	5	\$118.76
2.5	2.69	2.88	2.9	D3	x	2.69	2.88	2.9	D3	300	2 5/8 x 8	5	\$128.93
4	3.45	3.50	3.60	4T	x	3.45	3.50	3.60	4T	300	4 5/8 x 8	5	\$220.98
	3.75		4.05	F3A		3.75		4.05	F3A				
	4.05		4.35	F3B		4.05		4.35	F3B		4 5/8 x 11	7	\$254.66
	4.40	4.50	4.60	D3		4.40	4.50	4.60	D3				
	4.74	4.80	5.10	A1		4.74	4.80	5.10	A1				
5.10		5.30	E5	5.10		5.30	E5	4 5/8 x 14	10	\$305.11			
6	5.65		5.95	6T	x	5.65		5.95	6T	300	5 5/8 x 8	5	\$305.10
	5.85		6.15	F3A		5.85		6.15	F3A				
	6.15		6.45	F3B		6.15		6.45	F3B		5 5/8 x 11	7	\$344.45
	6.50	6.63	6.70	D3		6.50	6.63	6.70	D3				
	6.86	6.90	7.10	A1		6.86	6.90	7.10	A1				
7.15		7.35	E5	7.15		7.35	E5	5 - 5/8 x 14	10	\$411.74			
8	7.90		8.25	F3A	x	7.90		8.25	F3A	300	6 5/8 x 8	5	\$383.05
	8.25		8.55	F3B		8.25		8.55	F3B				
	8.55	8.63	8.75	D3		8.55	8.63	8.75	D3		6 5/8 x 11	7	\$433.79
	8.99	9.05	9.30	A1		8.99	9.05	9.30	A1				
	9.30		9.50	E5		9.30		9.50	E5				
6 - 5/8 x 14	10	\$534.74											
10**	9.85		10.20	F4A	x	9.85		10.20	F4A	300	7 5/8 x 11	7	\$640.28
	10.20		10.50	F4B		10.20		10.50	F4B				
	10.60	10.75	10.90	D4		10.60	10.75	10.90	D4				
	11.10	11.10	11.40	B2		11.10	11.10	11.40	B2		7 5/8 x 14	10***	\$766.08
	11.55		11.75	A1		11.55		11.75	A1				
	11.90		12.10	E5		11.90		12.10	E5				
<b>Series 2 (STANDARD STEEL AND DUCTILE SIZES ONLY)</b>													
10	10.60	10.75	10.90	S9	x	10.60	10.75	10.90	S9	300	6 5/8 x 10	6	\$553.99
	11.10	11.10	11.40	G8		11.10	11.10	11.40	G8				

All dimensions are in inches  
Continued....

Note: \* The high limit of the range is used in the ordering code.  
 \*\* Some transitions may required a stepped center sleeve.  
 \*\*\* Only available with end codes B2, A1 & E5

**ROBAR INDUSTRIES LTD.**

BC Phone (604) 591-8811 / 1-800-663-6553  
 Fax (604) 591-5288  
 Email: waterworks@robarindustries.com

**LES PRODUITS INDUSTRIELS ROBAR INC.**

QUEBEC Phone (450) 441-7525 / 1-800-315-9525  
 Fax (450) 441-4894  
 Web: www.Robarindustries.com



# 1406 CAST DUCTILE IRON COUPLINGS

STRAIGHT AND TRANSITION

PRICE INFORMATION

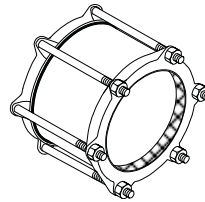

Nom Pipe Size	FIRST END				By X	SECOND END				MAX. Press (LBS/IN)	Fasteners No. Dia x Length	Sleeve Length (IN.)	List Price	
	RANGE					RANGE								
	Low	Pipe OD Actual	High*	End Code		Low	Pipe OD Actual	High*	End Code					
12**	12.00		12.30	F4A	x	12.00		12.30	F4A	300	8 5/8 x 11	7	\$ 729.64	
	12.30		12.60	F4B		12.30		12.60	F4B					
	12.60	12.75	12.90	D4		12.60	12.75	12.90	D4					
	13.20	13.20	13.60	B2		13.20	13.20	13.60	B2		8 5/8 x 14	10***		\$ 881.38
	13.80	14.00	14.10	A1		13.80	14.00	14.10	A1					
	14.10		14.35	E5		14.10		14.35	E5					
<b>Series 2 (STANDARD STEEL AND DUCTILE SIZES ONLY)</b>														
12	12.60	12.75	12.90	S9	x	12.60	12.75	12.90	S9	300	7 5/8 x 10	6	\$ 662.77	
	13.20	13.20	13.50	G8		13.20	13.20	13.50	G8					
14	14.60		14.90	F2	x	14.60		14.90	F2	150	9 5/8 x 11	7	\$1,198.83	
	15.30	15.30	15.70	B2		15.30	15.30	15.70	B2					
	15.80	16.00	16.25	A1		15.80	16.00	16.25	A1					
	16.40		16.80	E5		16.40		16.80	E5					
16	17.40	17.40	17.80	B2	x	17.40	17.40	17.80	B2	150	10 5/8 x 11	7	\$1,352.14	
	17.80	18.00	18.20	A1		17.80	18.00	18.20	A1					
	18.40		18.80	E5		18.40		18.80	E5					
18	18.80		19.20	B1	x	18.80		19.20	B1	150	12 5/8 x 11	7	\$1,752.67	
	19.10	19.50	19.70	A2		19.10	19.50	19.70	A2					
	19.70	20.00	20.25	E5		19.70	20.00	20.25	E5					
20	20.80		21.35	B1	x	20.80		21.35	B1	150	12 5/8 x 11	7	\$2,105.49	
	21.35	21.60	21.75	A2		21.35	21.60	21.75	A2					
	21.75	22.00	22.25	E5		21.75	22.00	22.25	E5					
22	22.95		23.35	B1	x	22.95		23.35	B1	150	13 5/8 x 11	7	\$2,325.47	
	23.45		23.85	A2		23.45		23.85	A2					
	23.75	24.00	24.25	E5		23.75	24.00	24.25	E5					
24	25.70	25.80	26.00	A2	x	25.70	25.80	26.00	A2	150	14 5/8 x 15	10	\$2,983.52	
	26.10		26.32	E5		26.10		26.32	E5					

All dimensions are in inches

Note: \* The high limit of the range is used in the ordering code.

\*\* Some transitions may require a stepped center sleeve.

\*\*\* Only available with end codes B2, A1 & E5

**ROBAR INDUSTRIES LTD.**

**BC** Phone (604) 591-8811 / 1-800-663-6553  
 Fax (604) 591-5288  
 Email: waterworks@robarindustries.com

**LES PRODUITS INDUSTRIELS ROBAR INC.**

**QUEBEC** Phone (450) 441-7525 / 1-800-315-9525  
 Fax (450) 441-4894  
 Web www.Robarindustries.com



# 1408 CAST DUCTILE IRON COUPLINGS

STRAIGHT & TRANSITION  
PRICE INFORMATION

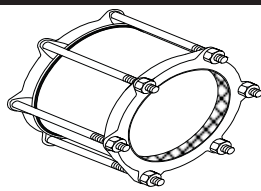

Nom Pipe Size	First End				By X	Second End				MAX. Press. (LBS/IN)	Fasteners No. Dia. X Length	Sleeve Length (IN.)	List Price	
	Range			End Code		Range			End Code					
	Low	Pipe OD Actual	High*			Low	Pipe OD Actual	High*						
2	2.35	2.38	2.5	D3	x	2.35	2.38	2.5	D3	300	2 5/8 x 8	5	\$94.71	
2.5	2.69	2.88	2.90	D3	x	2.69	2.88	2.90	D3	300	2 5/8 x 8	5	\$105.37	
4	3.45	3.50	3.60	4T	x	3.45	3.50	3.60	4T	300	4 5/8 x 8	5	\$154.44	
	3.75		4.05	F3A		3.75		4.05	F3A		4 5/8 x 8			
	4.05		4.35	F3B		4.05		4.35	F3B		4 5/8 x 11	7	\$185.02	
	4.40	4.50	4.60	D3		4.40	4.50	4.60	D3		4 5/8 x 14	10	\$240.56	
	4.74	4.80	5.10	A1		4.74	4.80	5.10	A1					
5.10		5.30	E5	5.10		5.30	E5							
6	5.65		5.95	6T	x	5.65		5.95	6T	300	5 5/8 x 8	5	\$222.44	
	5.85		6.15	F3A		5.85		6.15	F3A					
	6.15		6.45	F3B		6.15		6.45	F3B		5 5/8 x 11	7	\$257.91	
	6.50	6.63	6.70	D3		6.50	6.63	6.70	D3		5 - 5/8 x 14	10	\$308.40	
	6.86	6.90	7.10	A1		6.86	6.90	7.10	A1					
	7.15		7.35	E5		7.15		7.35	E5					
8	7.90		8.25	F3A	x	7.90		8.25	F3A	300	6 5/8 x 8	5	\$284.19	
	8.25		8.55	F3B		8.25		8.55	F3B					
	8.55	8.63	8.75	D3		8.55	8.63	8.75	D3		6 5/8 x 11	7	\$330.35	
	8.99	9.05	9.30	A1		8.99	9.05	9.30	A1		6 - 5/8 x 14	10	\$404.40	
	9.30		9.50	E5		9.30		9.50	E5					
10**	9.85		10.20	F4A	x	9.85		10.20	F4A	300	7 5/8 x 11	7	\$522.07	
	10.20		10.50	F4B		10.20		10.50	F4B					
	10.60	10.75	10.90	D4		10.60	10.75	10.90	D4					
	11.10	11.10	11.40	B2		11.10	11.10	11.40	B2					
	11.55		11.75	A1		11.55		11.75	A1		7 5/8 x 14	10***	\$670.41	
	11.90		12.10	E5		11.90		12.10	E5					
<b>Series 2 (STANDARD STEEL AND DUCTILE SIZES ONLY)</b>														
10	10.60	10.75	10.90	S9	x	10.60	10.75	10.90	S9	300	6 5/8 x 10	6	\$434.22	
	11.10	11.10	11.40	G8		11.10	11.10	11.40	G8					

All dimensions are in inches  
Continued....

Note: \* The high limit of the range is used in the ordering code.  
 \*\* Some transitions may required a stepped center sleeve.  
 \*\*\* Only available with end codes B2, A1 & E5

<b>ROBAR INDUSTRIES LTD.</b>	<b>LES PRODUITS INDUSTRIELS ROBAR INC.</b>
BC Phone (604) 591-8811 / 1-800-663-6553	QUEBEC Phone (450) 441-7525 / 1-800-315-9525
Fax (604) 591-5288	Fax (450) 441-4894
Email: waterworks@robarindustries.com	Web www.Robarindustries.com



# 1408 CAST DUCTILE IRON COUPLINGS

STRAIGHT & TRANSITION

PRICE INFORMATION

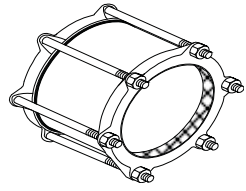

Nom Pipe Size	First End				By X	Second End				MAX. Press. (LBS/IN)	Fasteners No. Dia x Length	Sleeve Length (IN.)	List Price
	Range			End Code		Range			End Code				
	Low	Pipe OD Actual	High*			Low	Pipe OD Actual	High*					
12**	12.00		12.30	F4A	x	12.00		12.30	F4A	300	8 5/8 x 11	7	\$ 594.51
	12.30		12.60	F4B		12.30		12.60	F4B				
	12.60	12.75	12.90	D4		12.60	12.75	12.90	D4				
	13.20	13.20	13.60	B2		13.20	13.20	13.60	B2				
	13.80	14.00	14.10	A1		13.80	14.00	14.10	A1				
	14.10		14.35	E5		14.10		14.35	E5				
<b>Series 2 (STANDARD STEEL AND DUCTILE SIZES ONLY)</b>													
12	12.60	12.75	12.90	S9	x	12.60	12.75	12.90	S9	300	7 5/8 x 10	6	\$ 516.51
	13.20	13.20	13.50	G8		13.20	13.20	13.50	G8				
14	14.60		14.90	F2	x	14.60		14.90	F2	150	9 5/8 x 11	7	\$1,039.36
	15.30	15.30	15.70	B2		15.30	15.30	15.70	B2				
	15.80	16.00	16.25	A1		15.80	16.00	16.25	A1				
	16.40		16.80	E5		16.40		16.80	E5				
16	17.40	17.40	17.80	B2	x	17.40	17.40	17.80	B2	150	10 5/8 x 11	7	\$1,175.35
	17.80	18.00	18.20	A1		17.80	18.00	18.20	A1				
	18.40		18.80	E5		18.40		18.80	E5				
18	18.80		19.20	B1	x	18.80		19.20	B1	150	12 5/8 x 11	7	\$1,542.92
	19.10	19.50	19.70	A2		19.10	19.50	19.70	A2				
	19.70	20.00	20.25	E5		19.70	20.00	20.25	E5				
20	20.80		21.35	B1	x	20.80		21.35	B1	150	12 5/8 x 11	7	\$1,902.23
	21.35	21.60	21.75	A2		21.35	21.60	21.75	A2				
	21.75	22.00	22.25	E5		21.75	22.00	22.25	E5				
22	22.95		23.35	B1	x	22.95		23.35	B1	150	13 5/8 x 11	7	\$2,106.12
	23.45		23.85	A2		23.45		23.85	A2				
	23.75	24.00	24.25	E5		23.75	24.00	24.25	E5				
24	25.70	25.80	26.00	A2	x	25.70	25.80	26.00	A2	150	14 5/8 x 15	10	\$2,334.67
	26.10		26.32	E5		26.10		26.32	E5				

All dimensions are in inches

Note: \* The high limit of the range is used in the ordering code.  
 \*\* Some transitions may required a stepped center sleeve.  
 \*\*\* Only available with end codes B2, A1 & E5

<b>ROBAR INDUSTRIES LTD.</b>	<b>LES PRODUITS INDUSTRIELS ROBAR INC.</b>
BC Phone (604) 591-8811 / 1-800-663-6553	QUEBEC Phone (450) 441-7525 / 1-800-315-9525
Fax (604) 591-5288	Fax (450) 441-4894
Email waterworks@robarindustries.com	Web www.Robarindustries.com

# 1506 CAST DUCTILE IRON COUPLINGS

STRAIGHT & TRANSITION

PRICE INFORMATION

ROBAR

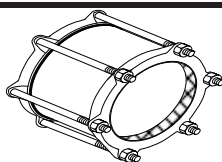

Nom Pipe Size	First End				By X	Second End				MAX. Press. (LBS/IN)	Fasteners No. Dia x Length	Sleeve Length (IN.)	List Price
	Range			End Code		Range			End Code				
	Low	Pipe OD Actual	High*			Low	Pipe OD Actual	High*					
2	2.35	2.38	2.5	D3	x	2.35	2.38	2.5	D3	300	2 5/8 x 8	5	\$144.02
2.5	2.69	2.88	2.90	D3	x	2.69	2.88	2.90	D3	300	2 5/8 x 8	5	\$154.17
4	3.45	3.50	3.60	4T	x	3.45	3.50	3.60	4T	300	4 5/8 x 8	5	\$275.98
	3.75		4.05	F3A		3.75		4.05	F3A				
	4.05		4.35	F3B		4.05		4.35	F3B		4 5/8 x 11	7	\$326.40
	4.40	4.50	4.60	D3		4.40	4.50	4.60	D3				
	4.74	4.80	5.10	A1		4.74	4.80	5.10	A1				
5.10		5.30	E5	5.10		5.30	E5	4 5/8 x 14	10	\$375.22			
6	5.65		5.95	6T	x	5.65		5.95	6T	300	5 5/8 x 8	5	\$391.56
	5.85		6.15	F3A		5.85		6.15	F3A				
	6.15		6.45	F3B		6.15		6.45	F3B		5 5/8 x 11	7	\$450.07
	6.50	6.63	6.70	D3		6.50	6.63	6.70	D3				
	6.86	6.90	7.10	A1		6.86	6.90	7.10	A1				
7.15		7.35	E5	7.15		7.35	E5	5 - 5/8 x 14	10	\$500.57			
8	7.90		8.25	F3A	x	7.90		8.25	F3A	300	6 5/8 x 8	5	\$491.37
	8.25		8.55	F3B		8.25		8.55	F3B				
	8.55	8.63	8.75	D3		8.55	8.63	8.75	D3		6 5/8 x 11	7	\$567.29
	8.99	9.05	9.30	A1		8.99	9.05	9.30	A1				
	9.30		9.50	E5		9.30		9.50	E5				
10**	9.85		10.20	F4A	x	9.85		10.20	F4A	300	7 5/8 x 11	7	\$794.40
	10.20		10.50	F4B		10.20		10.50	F4B				
	10.60	10.75	10.90	D4		10.60	10.75	10.90	D4		7 5/8 x 14	10***	\$895.38
	11.10	11.10	11.40	B2		11.10	11.10	11.40	B2				
	11.55		11.75	A1		11.55		11.75	A1				
11.90		12.10	E5	11.90		12.10	E5						
<b>Series 2 (STANDARD STEEL AND DUCTILE SIZES ONLY)</b>													
10	10.60	10.75	10.90	S9	x	10.60	10.75	10.90	S9	300	6 5/8 x 10	6	\$694.27
	11.10	11.10	11.40	G8		11.10	11.10	11.40	G8				

All dimensions are in inches

Continued....

Note: \* The high limit of the range is used in the ordering code.

\*\* Some transitions may required a stepped center sleeve.

\*\*\* Only available with end codes B2, A1 & E5

**ROBAR INDUSTRIES LTD.**

**BC** Phone (604) 591-8811 / 1-800-663-6553  
 Fax (604) 591-5288  
 Email: waterworks@robarindustries.com

**LES PRODUITS INDUSTRIELS ROBAR INC.**

**QUEBEC** Phone (450) 441-7525 / 1-800-315-9525  
 Fax (450) 441-4894  
 Web www.Robarindustries.com



# 1506 CAST DUCTILE IRON COUPLINGS

STRAIGHT & TRANSITION

PRICE INFORMATION

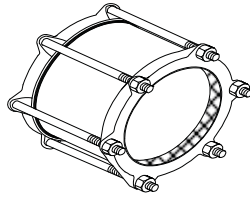

Nom Pipe Size	First End				By X	Second End				MAX. Press. (LBS/IN)	Fasteners No. Dia x Length	Sleeve Length (IN.)	List Price
	Range					Range							
	Low	Pipe OD Actual	High*	End Code		Low	Pipe OD Actual	High*	End Code				
12**	12.00		12.30	F4A	x	12.00		12.30	F4A	300	8 5/8 x 11	7	\$ 897.56
	12.30		12.60	F4B		12.30		12.60	F4B				
	12.60	12.75	12.90	D4		12.60	12.75	12.90	D4				
	13.20	13.20	13.60	B2		13.20	13.20	13.60	B2				
	13.80	14.00	14.10	A1		13.80	14.00	14.10	A1				
	14.10		14.35	E5		14.10		14.35	E5				
12**					x					300	8 5/8 x 14	10***	\$ 1,040.58

**Series 2 (STANDARD STEEL AND DUCTILE SIZES ONLY)**

12	12.60	12.75	12.90	S9	x	12.60	12.75	12.90	S9	300	7 5/8 x 10	6	\$ 821.51
	13.20	13.20	13.50	G8		13.20	13.20	13.50	G8				
14	14.60		14.90	F2	x	14.60		14.90	F2	150	9 5/8 x 11	7	\$1,571.17
	15.30	15.30	15.70	B2		15.30	15.30	15.70	B2				
	15.80	16.00	16.25	A1		15.80	16.00	16.25	A1				
	16.40		16.80	E5		16.40		16.80	E5				
16	17.40	17.40	17.80	B2	x	17.40	17.40	17.80	B2	150	10 5/8 x 11	7	\$1,738.21
	17.80	18.00	18.20	A1		17.80	18.00	18.20	A1				
	18.40		18.80	E5		18.40		18.80	E5				
18	18.80		19.20	B1	x	18.80		19.20	B1	150	12 5/8 x 11	7	\$2,103.83
	19.10	19.50	19.70	A2		19.10	19.50	19.70	A2				
	19.70	20.00	20.25	E5		19.70	20.00	20.25	E5				
20	20.80		21.35	B1	x	20.80		21.35	B1	150	12 5/8 x 11	7	\$2,408.44
	21.35	21.60	21.75	A2		21.35	21.60	21.75	A2				
	21.75	22.00	22.25	E5		21.75	22.00	22.25	E5				
22	22.95		23.35	B1	x	22.95		23.35	B1	150	13 5/8 x 11	7	\$2,665.54
	23.45		23.85	A2		23.45		23.85	A2				
	23.75	24.00	24.25	E5		23.75	24.00	24.25	E5				
24	25.70	25.80	26.00	A2	x	25.70	25.80	26.00	A2	150	14 5/8 x 15	10	\$3,350.26
	26.10		26.32	E5		26.10		26.32	E5				

*All dimensions are in inches*

Note: \* The high limit of the range is used in the ordering code.  
 \*\* Some transitions may require a stepped center sleeve.  
 \*\*\* Only available with end codes B2, A1 & E5

**ROBAR INDUSTRIES LTD.**

BC Phone (604) 591-8811 / 1-800-663-6553  
 Fax (604) 591-5288  
 Email waterworks@robarindustries.com

**LES PRODUITS INDUSTRIELS ROBAR INC.**

QUEBEC Phone (450) 441-7525 / 1-800-315-9525  
 Fax (450) 441-4894  
 Web www.Robarindustries.com



# 1507 CAST DUCTILE IRON COUPLINGS

STRAIGHT & TRANSITION  
PRICE INFORMATION

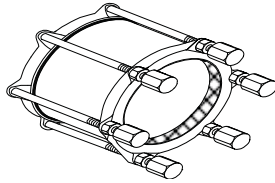

Nom Pipe Size	First End				By X	Second End				MAX. Press. (LBS/IN)	Fasteners No. Dia x Length	Sleeve Length (IN.)	List Price
	Range			End Code		Range			End Code				
	Low	Pipe OD Actual	High*			Low	Pipe OD Actual	High*					
2	2.35	2.38	2.5	D3	x	2.35	2.38	2.5	D3	300	2 5/8 x 8	5	\$165.31
2.5	2.69	2.88	2.90	D3	x	2.69	2.88	2.90	D3	300	2 5/8 x 8	5	\$199.00
4	3.45	3.50	3.60	4T	x	3.45	3.50	3.60	4T	300	4 5/8 x 8	5	\$313.21
	3.75		4.05	F3A		3.75		4.05	F3A				
	4.05		4.35	F3B		4.05		4.35	F3B				
	4.40	4.50	4.60	D3		4.40	4.50	4.60	D3				
	4.74	4.80	5.10	A1		4.74	4.80	5.10	A1				
	5.10		5.30	E5		5.10		5.30	E5				
6	5.85		6.15	F3A	x	5.85		6.15	F3A	300	5 5/8 x 8	5	\$438.08
	6.15		6.45	F3B		6.15		6.45	F3B				
	6.50	6.63	6.70	D3		6.50	6.63	6.70	D3				
	6.86	6.90	7.10	A1		6.86	6.90	7.10	A1				
	7.15		7.35	E5		7.15		7.35	E5				
8	7.90		8.25	F3A	x	7.90		8.25	F3A	300	6 5/8 x 8	5	\$547.19
	8.25		8.55	F3B		8.25		8.55	F3B				
	8.55	8.63	8.75	D3		8.55	8.63	8.75	D3				
	8.99	9.05	9.30	A1		8.99	9.05	9.30	A1				
	9.30		9.50	E5		9.30		9.50	E5				
10**	9.85		10.20	F4A	x	9.85		10.20	F4A	300	7 5/8 x 11	7	\$855.39
	10.20		10.50	F4B		10.20		10.50	F4B				
	10.60	10.75	10.90	D4		10.60	10.75	10.90	D4				
	11.10	11.10	11.40	B2		11.10	11.10	11.40	B2				
	11.55		11.75	A1		11.55		11.75	A1				
	11.90		12.10	E5		11.90		12.10	E5				
<b>Series 2 (STANDARD STEEL AND DUCTILE SIZES ONLY)</b>													
10	10.60	10.75	10.90	S9	x	10.60	10.75	10.90	S9	300	6 5/8 x 10	6	\$755.27
	11.10	11.10	11.40	G8		11.10	11.10	11.40	G8				

All dimensions are in inches  
Continued....

Note: \* The high limit of the range is used in the ordering code.  
\*\* Some transitions may required a stepped center sleeve.

## ROBAR INDUSTRIES LTD.

BC Phone (604) 591-8811 / 1-800-663-6553  
Fax (604) 591-5288  
Email: waterworks@robarindustries.com

## LES PRODUITS INDUSTRIELS ROBAR INC.

QUEBEC Phone (450) 441-7525 / 1-800-315-9525  
Fax (450) 441-4894  
Web www.Robarindustries.com

# 1507 CAST DUCTILE IRON COUPLINGS

STRAIGHT & TRANSITION  
PRICE INFORMATION

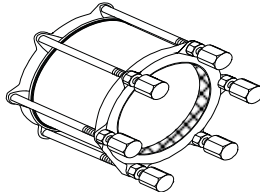

Nom Pipe Size	First End				By X	Second End				MAX. Press. (LBS/IN)	Fasteners No. Dia x Length	Sleeve Length (IN.)	List Price
	Range					Range							
	Low	Pipe OD Actual	High*	End Code		Low	Pipe OD Actual	High*	End Code				
12**	12.00		12.30	F4A	x	12.00		12.30	F4A	300	8 5/8 x 11	7	\$ 967.33
	12.30		12.60	F4B		12.30		12.60	F4B				
	12.60	12.75	12.90	D4		12.60	12.75	12.90	D4				
	13.20	13.20	13.60	B2		13.20	13.20	13.60	B2				
	13.80	14.00	14.10	A1		13.80	14.00	14.10	A1				
	14.10		14.35	E5		14.10		14.35	E5				
<b>Series 2 (STANDARD STEEL AND DUCTILE SIZES ONLY)</b>													
12	12.60	12.75	12.90	S9	x	12.60	12.75	12.90	S9	300	7 5/8 x 10	6	\$ 895.90
	13.20	13.20	13.50	G8		13.20	13.20	13.50	G8				
14	14.60		14.90	F2	x	14.60		14.90	F2	150	9 5/8 x 11	7	\$1,655.65
	15.30	15.30	15.70	B2		15.30	15.30	15.70	B2				
	15.80	16.00	16.25	A1		15.80	16.00	16.25	A1				
	16.40		16.80	E5		16.40		16.80	E5				
16	17.40	17.40	17.80	B2	x	17.40	17.40	17.80	B2	150	10 5/8 x 11	7	\$1,833.02
	17.80	18.00	18.20	A1		17.80	18.00	18.20	A1				
	18.40		18.80	E5		18.40		18.80	E5				
18	18.80		19.20	B1	x	18.80		19.20	B1	150	12 5/8 x 11	7	\$2,217.49
	19.10	19.50	19.70	A2		19.10	19.50	19.70	A2				
	19.70	20.00	20.25	E5		19.70	20.00	20.25	E5				
20	20.80		21.35	B1	x	20.80		21.35	B1	150	12 5/8 x 11	7	\$2,522.13
	21.35	21.60	21.75	A2		21.35	21.60	21.75	A2				
	21.75	22.00	22.25	E5		21.75	22.00	22.25	E5				
22	22.95		23.35	B1	x	22.95		23.35	B1	150	13 5/8 x 11	7	\$2,788.68
	23.45		23.85	A2		23.45		23.85	A2				
	23.75	24.00	24.25	E5		23.75	24.00	24.25	E5				
24	25.70	25.80	26.00	A2	x	25.70	25.80	26.00	A2	150	14 5/8 x 15	10	\$3,101.41
	26.10		26.32	E5		26.10		26.32	E5				

All dimensions are in inches

Note: \* The high limit of the range is used in the ordering code.  
\*\* Some transitions may required a stepped center sleeve.

## ROBAR INDUSTRIES LTD.

BC Phone (604) 591-8811 / 1-800-663-6553  
Fax (604) 591-5288  
Email: waterworks@robarindustries.com

## LES PRODUITS INDUSTRIELS ROBAR INC.

QUEBEC Phone (450) 441-7525 / 1-800-315-9525  
Fax (450) 441-4894  
Web www.Robarindustries.com





# 1508 CAST DUCTILE IRON COUPLINGS

STRAIGHT & TRANSITION  
PRICE INFORMATION

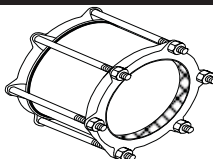

Nom Pipe Size	First End				By X	Second End				MAX. Press. (LBS/IN)	Fasteners No. Dia x Length	Sleeve Length (IN.)	List Price
	Range			End Code		Range			End Code				
	Low	Pipe OD Actual	High*			Low	Pipe OD Actual	High*					
2	2.35	2.38	2.5	D3	x	2.35	2.38	2.5	D3	300	2 5/8 x 8	5	\$126.54
2.5	2.69	2.88	2.90	D3	x	2.69	2.88	2.90	D3	300	2 5/8 x 8	5	\$136.92
4	3.45	3.50	3.60	4T	x	3.45	3.50	3.60	4T	300	4 5/8 x 8	5	\$209.61
	3.75		4.05	F3A		3.75		4.05	F3A				
	4.05		4.35	F3B		4.05		4.35	F3B				
	4.40	4.50	4.60	D3		4.40	4.50	4.60	D3				
	4.74	4.80	5.10	A1		4.74	4.80	5.10	A1				
	5.10		E5		5.10		E5			4 5/8 x 14	10	\$304.26	
6	5.85		6.15	F3A	x	5.85		6.15	F3A	300	5 5/8 x 8	5	\$291.98
	6.15		6.45	F3B		6.15		6.45	F3B				
	6.50	6.63	6.70	D3		6.50	6.63	6.70	D3				
	6.86	6.90	7.10	A1		6.86	6.90	7.10	A1				
	7.15		7.35	E5		7.15		7.35	E5				
										5 - 5/8 x 14	10	\$388.33	
8	7.90		8.25	F3A	x	7.90		8.25	F3A	300	6 5/8 x 8	5	\$368.71
	8.25		8.55	F3B		8.25		8.55	F3B				
	8.55	8.63	8.75	D3		8.55	8.63	8.75	D3				
	8.99	9.05	9.30	A1		8.99	9.05	9.30	A1				
	9.30		9.50	E5		9.30		9.50	E5				
										6 - 5/8 x 14	10	\$511.17	
10**	9.85		10.20	F4A	x	9.85		10.20	F4A	300	7 5/8 x 11	7	\$613.91
	10.20		10.50	F4B		10.20		10.50	F4B				
	10.60	10.75	10.90	D4		10.60	10.75	10.90	D4				
	11.10	11.10	11.40	B2		11.10	11.10	11.40	B2				
	11.55		11.75	A1		11.55		11.75	A1				
	11.90		12.10	E5		11.90		12.10	E5				
										7 5/8 x 14	10***	\$730.17	
<b>Series 2 (STANDARD STEEL AND DUCTILE SIZES ONLY)</b>													
10	10.60	10.75	10.90	S9	x	10.60	10.75	10.90	S9	300	6 5/8 x 10	6	\$537.19
	11.10	11.10	11.40	G8		11.10	11.10	11.40	G8				

All dimensions are in inches  
Continued...

Note: \* The high limit of the range is used in the ordering code.  
 \*\* Some transitions may required a stepped center sleeve.  
 \*\*\* Only available with end codes B2, A1 & E5

<b>ROBAR INDUSTRIES LTD.</b>	<b>LES PRODUITS INDUSTRIELS ROBAR INC.</b>
<b>BC</b> Phone (604) 591-8811 / 1-800-663-6553	<b>QUEBEC</b> Phone (450) 441-7525 / 1-800-315-9525
Fax (604) 591-5288	Fax (450) 441-4894
Email: waterworks@robarindustries.com	Web www.Robarindustries.com



# 1508 CAST DUCTILE IRON COUPLINGS

STRAIGHT & TRANSITION  
PRICE INFORMATION

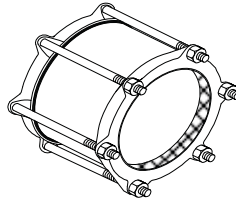

Nom Pipe Size	First End				By X	Second End				MAX. Press. (LBS/IN)	Fasteners No. Dia x Length	Sleeve Length (IN.)	List Price
	Range			End Code		Range			End Code				
	Low	Pipe OD Actual	High*			Low	Pipe OD Actual	High*					
12**	12.00		12.30	F4A	x	12.00		12.30	F4A	300	8 5/8 x 11	7	\$ 728.08
	12.30		12.60	F4B		12.30		12.60	F4B				
	12.60	12.75	12.90	D4		12.60	12.75	12.90	D4				
	13.20	13.20	13.60	B2		13.20	13.20	13.60	B2				
	13.80	14.00	14.10	A1		13.80	14.00	14.10	A1				
	14.10		14.35	E5		14.10		14.35	E5				
<b>Series 2 (STANDARD STEEL AND DUCTILE SIZES ONLY)</b>													
12	12.60	12.75	12.90	S9	x	12.60	12.75	12.90	S9	300	7 5/8 x 10	6	\$ 668.22
	13.20	13.20	13.50	G8		13.20	13.20	13.50	G8				
14	14.60		14.90	F2	x	14.60		14.90	F2	150	9 5/8 x 11	7	\$ 1,240.92
	15.30	15.30	15.70	B2		15.30	15.30	15.70	B2				
	15.80	16.00	16.25	A1		15.80	16.00	16.25	A1				
	16.40		16.80	E5		16.40		16.80	E5				
16	17.40	17.40	17.80	B2	x	17.40	17.40	17.80	B2	150	10 5/8 x 11	7	\$ 1,499.21
	17.80	18.00	18.20	A1		17.80	18.00	18.20	A1				
	18.40		18.80	E5		18.40		18.80	E5				
18	18.80		19.20	B1	x	18.80		19.20	B1	150	12 5/8 x 11	7	\$ 1,772.47
	19.10	19.50	19.70	A2		19.10	19.50	19.70	A2				
	19.70	20.00	20.25	E5		19.70	20.00	20.25	E5				
20	20.80		21.35	B1	x	20.80		21.35	B1	150	12 5/8 x 11	7	\$ 1,998.95
	21.35	21.60	21.75	A2		21.35	21.60	21.75	A2				
	21.75	22.00	22.25	E5		21.75	22.00	22.25	E5				
22	22.95		23.35	B1	x	22.95		23.35	B1	150	13 5/8 x 11	7	\$ 2,208.58
	23.45		23.85	A2		23.45		23.85	A2				
	23.75	24.00	24.25	E5		23.75	24.00	24.25	E5				
24	25.70	25.80	26.00	A2	x	25.70	25.80	26.00	A2	150	14 5/8 x 15	10	\$ 2,646.55
	26.10		26.32	E5		26.10		26.32	E5				

All dimensions are in inches

Note: \* The high limit of the range is used in the ordering code.  
 \*\* Some transitions may required a stepped center sleeve.  
 \*\*\* Only available with end codes B2, A1 & E5

**ROBAR INDUSTRIES LTD.**

BC Phone (604) 591-8811 / 1-800-663-6553  
 Fax (604) 591-5288  
 Email: waterworks@robarindustries.com

**LES PRODUITS INDUSTRIELS ROBAR INC.**

QUEBEC Phone (450) 441-7525 / 1-800-315-9525  
 Fax (450) 441-4894  
 Web www.Robarindustries.com



# 1519 CAST DUCTILE IRON COUPLINGS

STRAIGHT & TRANSITION  
PRICE INFORMATION

Nom Pipe Size	First End				By X	Second End				MAX. Press. (LBS/IN)	Fasteners No. Dia x Length	Sleeve Length (IN.)	List Price
	Range			End Code		Range			End Code				
	Low	Pipe OD Actual	High*			Low	Pipe OD Actual	High*					
2	2.35	2.38	2.5	D3	x	2.35	2.38	2.5	D3	300	2 5/8 x 8	5	\$139.55
2.5	2.69	2.88	2.90	D3	x	2.69	2.88	2.90	D3	300	2 5/8 x 8	5	\$150.60
4	3.45	3.50	3.60	4T	x	3.45	3.50	3.60	4T	300	4 5/8 x 8	5	\$240.48
	3.75		4.05	F3A		3.75		4.05	F3A				
	4.05		4.35	F3B		4.05		4.35	F3B				
	4.40	4.50	4.60	D3		4.40	4.50	4.60	D3		4 5/8 x 11	7	\$288.65
	4.74	4.80	5.10	A1		4.74	4.80	5.10	A1				
	5.10		5.30	E5		5.10		5.30	E5				
6	5.85		6.15	F3A	x	5.85		6.15	F3A	300	5 5/8 x 8	5	\$345.34
	6.15		6.45	F3B		6.15		6.45	F3B				
	6.50	6.63	6.70	D3		6.50	6.63	6.70	D3				
	6.86	6.90	7.10	A1		6.86	6.90	7.10	A1		5 5/8 x 11	7	\$401.11
	7.15		7.35	E5		7.15		7.35	E5				
8	7.90		8.25	F3A	x	7.90		8.25	F3A	300	6 5/8 x 8	5	\$443.32
	8.25		8.55	F3B		8.25		8.55	F3B				
	8.55	8.63	8.75	D3		8.55	8.63	8.75	D3				
	8.99	9.05	9.30	A1		8.99	9.05	9.30	A1		6 5/8 x 11	7	\$506.86
	9.30		9.50	E5		9.30		9.50	E5				
10**	9.85		10.20	F4A	x	9.85		10.20	F4A	300	7 5/8 x 11	7	\$722.72
	10.20		10.50	F4B		10.20		10.50	F4B				
	10.60	10.75	10.90	D4		10.60	10.75	10.90	D4				
	11.10	11.10	11.40	B2		11.10	11.10	11.40	B2				
	11.55		11.75	A1		11.55		11.75	A1				
	11.90		12.10	E5		11.90		12.10	E5				
<b>Series 2 (STANDARD STEEL AND DUCTILE SIZES ONLY)</b>													
10	10.60	10.75	10.90	S9	x	10.60	10.75	10.90	S9	300	6 5/8 x 10	6	\$622.58
	11.10	11.10	11.40	G8		11.10	11.10	11.40	G8				

All dimensions are in inches  
Continued....

Note: \* The high limit of the range is used in the ordering code.  
\*\* Some transitions may required a stepped center sleeve.

## ROBAR INDUSTRIES LTD.

BC Phone (604) 591-8811 / 1-800-663-6553  
Fax (604) 591-5288  
Email: waterworks@robarindustries.com

## LES PRODUITS INDUSTRIELS ROBAR INC.

QUEBEC Phone (450) 441-7525 / 1-800-315-9525  
Fax (450) 441-4894  
Web www.Robarindustries.com



# 1519 CAST DUCTILE IRON COUPLINGS

STRAIGHT & TRANSITION  
PRICE INFORMATION

Nom Pipe Size	First End				By X	Second End				MAX. Press. (LBS/IN)	Fasteners No. Dia x Length	Sleeve Length (IN.)	List Price
	Range			End Code		Range			End Code				
	Low	Pipe OD Actual	High*			Low	Pipe OD Actual	High*					
12**	12.00		12.30	F4A	x	12.00		12.30	F4A	300	8 5/8 x 11	7	\$ 814.55
	12.30		12.60	F4B		12.30		12.60	F4B				
	12.60	12.75	12.90	D4		12.60	12.75	12.90	D4				
	13.20	13.20	13.60	B2		13.20	13.20	13.60	B2				
	13.80	14.00	14.10	A1		13.80	14.00	14.10	A1				
	14.10		14.35	E5		14.10		14.35	E5				
<b>Series 2 (STANDARD STEEL AND DUCTILE SIZES ONLY)</b>													
12	12.60	12.75	12.90	S9	x	12.60	12.75	12.90	S9	300	7 5/8 x 10	6	\$ 732.98
	13.20	13.20	13.50	G8		13.20	13.20	13.50	G8				
14	14.60		14.90	F2	x	14.60		14.90	F2	150	9 5/8 x 11	7	\$ 1,468.78
	15.30	15.30	15.70	B2		15.30	15.30	15.70	B2				
	15.80	16.00	16.25	A1		15.80	16.00	16.25	A1				
	16.40		16.80	E5		16.40		16.80	E5				
16	17.40	17.40	17.80	B2	x	17.40	17.40	17.80	B2	150	10 5/8 x 11	7	\$ 1,623.59
	17.80	18.00	18.20	A1		17.80	18.00	18.20	A1				
	18.40		18.80	E5		18.40		18.80	E5				
18	18.80		19.20	B1	x	18.80		19.20	B1	150	12 5/8 x 11	7	\$ 1,964.52
	19.10	19.50	19.70	A2		19.10	19.50	19.70	A2				
	19.70	20.00	20.25	E5		19.70	20.00	20.25	E5				
20	20.80		21.35	B1	x	20.80		21.35	B1	150	12 5/8 x 11	7	\$ 2,269.12
	21.35	21.60	21.75	A2		21.35	21.60	21.75	A2				
	21.75	22.00	22.25	E5		21.75	22.00	22.25	E5				
22	22.95		23.35	B1	x	22.95		23.35	B1	150	13 5/8 x 11	7	\$ 2,513.86
	23.45		23.85	A2		23.45		23.85	A2				
	23.75	24.00	24.25	E5		23.75	24.00	24.25	E5				
24	25.70	25.80	26.00	A2	x	25.70	25.80	26.00	A2	150	14 5/8 x 15	10	\$ 2,804.87
	26.10		26.32	E5		26.10		26.32	E5				

All dimensions are in inches

Note: \* The high limit of the range is used in the ordering code.  
\*\* Some transitions may required a stepped center sleeve.

## ROBAR INDUSTRIES LTD.

BC Phone (604) 591-8811 / 1-800-663-6553  
Fax (604) 591-5288  
Email: waterworks@robarindustries.com

## LES PRODUITS INDUSTRIELS ROBAR INC.

QUEBEC Phone (450) 441-7525 / 1-800-315-9525  
Fax (450) 441-4894  
Web www.Robarindustries.com



# 1406R REDUCING COUPLINGS

CAST DUCTILE IRON  
PRICE INFORMATION

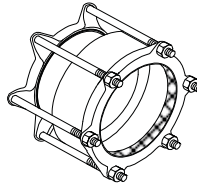

Nom Pipe Size	First End				By X	Second End				MAX. Press. (LBS/IN)	Fasteners No. Dia x Length	Sleeve length (IN.)	List Price
	Range					Range							
	Low	Pipe OD Actual	High*	End Code		Low	Pipe OD Actual	High*	End Code				
6 x 4	5.85		6.15	F3A	x	3.45	3.50	3.60	4T	300	5 5/8 x 8	5	\$393.56
	6.15		6.45	F3B		3.75		4.05	F3A				
	6.50	6.63	6.70	D3		4.05		4.35	F3B				
	6.86	6.90	7.10	A1		4.40	4.50	4.60	D3				
	7.15		7.35	E5		4.74	4.80	5.10	A1				
						5.10		5.30	E5				
8 x 6	7.90		8.25	F3A	x	5.85		6.15	F3A	300	6 5/8 x 8	5	\$500.38
	8.25		8.55	F3B		6.15		6.45	F3B				
	8.55	8.63	8.75	D3		6.50	6.63	6.70	D3				
	8.99	9.05	9.30	A1		6.86	6.90	7.10	A1				
	9.30		9.50	E5		7.15		7.35	E5				
10 x 8	9.85		10.20	F4A	x	7.90		8.25	F3A	300	7 5/8 x 11	7	\$775.42
	10.20		10.50	F4B		8.25		8.55	F3B				
	10.60	10.75	10.90	D4		8.55	8.63	8.75	D3				
	11.10	11.10	11.40	B2		8.99	9.05	9.30	A1				
	11.55		11.75	A1		9.30		9.50	E5				
	11.90		12.10	E5									
12 x 10	12.00		12.30	F4A	x	9.85		10.20	F4A	300	8 5/8 x 11	7	\$887.07
	12.30		12.60	F4B		10.20		10.50	F4B				
	12.60	12.75	12.90	D4		10.60	10.75	10.90	D4				
	13.20	13.20	13.60	B2		11.10	11.10	11.40	B2				
	13.80	14.00	14.10	A1		11.55		11.75	A1				
	14.10		14.35	E5		11.90		12.10	E5				
14 x 12	14.60		14.90	F2	x	12.00		12.30	F4A	150	9 5/8 x 11	7	\$1,332.54
	15.30	15.30	15.70	B2		12.30		12.60	F4B				
	15.80	16.00	16.25	A1		12.60	12.75	12.90	D4				
	16.40		16.80	E5		13.20	13.20	13.60	B2				
						13.80	14.00	14.10	A1				
						14.10		14.35	E5				

All dimensions are in inches  
Continued....

Note: \* The high limit of the range is used in the ordering code.

## ROBAR INDUSTRIES LTD.

BC Phone (604) 591-8811 / 1-800-663-6553  
Fax (604) 591-5288  
Email: waterworks@robarindustries.com

## LES PRODUITS INDUSTRIELS ROBAR INC.

QUEBEC Phone (450) 441-7525 / 1-800-315-9525  
Fax (450) 441-4894  
Web www.Robarindustries.com



# 1406R REDUCING COUPLINGS

CAST DUCTILE IRON  
PRICE INFORMATION

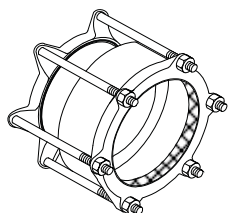

Nom Pipe Size	First End				By X	Second End				MAX. Press. (LBS/IN)	Fasteners No. Dia x Length	Sleeve Length (IN.)	List Price
	Range					Range							
	Low	Pipe OD Actual	High*	End Code		Low	Pipe OD Actual	High*	End Code				
16 x 14					x	14.60		14.90	F2	150	10 5/8 x 11	7	\$1,624.54
	17.40	17.40	17.80	B2		15.30	15.30	15.70	B2				
	17.80	18.00	18.20	A1		15.80	16.00	16.25	A1				
	18.40		18.80	E5		16.40		16.80	E5				
18 x 16	18.80		19.20	B1	x	17.40	17.40	17.80	B2	150	12 5/8 x 11	7	\$2,017.11
	19.10	19.50	19.70	A2		17.80	18.00	18.20	A1				
	19.70	20.00	20.25	E5		18.40		18.80	E5				
20 x 16	20.80		21.35	B1	x	17.40	17.40	17.80	B2	150	12 5/8 x 11	7	\$2,328.58
	21.35	21.60	21.75	A2		17.80	18.00	18.20	A1				
	21.75	22.00	22.25	E5		18.40		18.80	E5				
20 x 18	20.80		21.35	B1	x	18.80		19.20	B1	150	12 5/8 x 11	7	\$2,263.91
	21.35	21.60	21.75	A2		19.10	19.50	19.70	A2				
	21.75	22.00	22.25	E5		19.70	20.00	20.25	E5				
22 x 16	22.95		23.35	B1	x	17.40	17.40	17.80	B2	150	13 5/8 x 11	7	\$2,608.62
	23.45		23.85	A2		17.80	18.00	18.20	A1				
	23.75	24.00	24.25	E5		18.40		18.80	E5				
22 x 18	22.95		23.35	B1	x	18.80		19.20	B1	150	13 5/8 x 11	7	\$2,602.97
	23.45		23.85	A2		19.10	19.50	19.70	A2				
	23.75	24.00	24.25	E5		19.70	20.00	20.25	E5				
22 x 20	22.95		23.35	B1	x	20.80		21.35	B1	150	13 5/8 x 11	7	\$2,407.41
	23.45		23.85	A2		21.35	21.60	21.75	A2				
	23.75	24.00	24.25	E5		21.75	22.00	22.25	E5				
24 x 22	25.70	25.80	26.00	A2	x	22.95		23.35	B1	150	14 5/8 x 15	10	\$3,244.30
	26.10		26.32	E5		23.45		23.85	A2				
						23.75	24.00	24.25	E5				

All dimensions are in inches

Note: \* The high limit of the range is used in the ordering code.

**ROBAR INDUSTRIES LTD.**  
**BC** Phone (604) 591-8811 / 1-800-663-6553  
 Fax (604) 591-5288  
 Email: waterworks@robarindustries.com

**LES PRODUITS INDUSTRIELS ROBAR INC.**  
**QUEBEC** Phone (450) 441-7525 / 1-800-315-9525  
 Fax (450) 441-4894  
 Web www.Robarindustries.com



# 1408R REDUCING COUPLINGS

CAST DUCTILE IRON  
PRICE INFORMATION

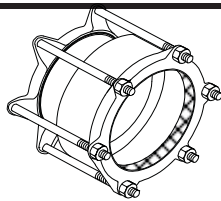

Nom Pipe Size	First End				By X	Second End				MAX. Press. (LBS/IN)	Fasteners No. Dia x Length	Sleeve Length (IN.)	List Price
	Range					Range							
	Low	Pipe OD Actual	High*	End Code		Low	Pipe OD Actual	High*	End Code				
6 x 4	5.85		6.15	F3A	x	3.45	3.50	3.60	4T	300	5 5/8 x 8	5	\$312.40
	6.15		6.45	F3B		3.75		4.05	F3A				
	6.50	6.63	6.70	D3		4.05		4.35	F3B				
	6.86	6.90	7.10	A1		4.40	4.50	4.60	D3				
	7.15		7.35	E5		4.74	4.80	5.10	A1				
						5.10		5.30	E5				
8 x 6	7.90		8.25	F3A	x	5.85		6.15	F3A	300	6 5/8 x 8	5	\$403.65
	8.25		8.55	F3B		6.15		6.45	F3B				
	8.55	8.63	8.75	D3		6.50	6.63	6.70	D3				
	8.99	9.05	9.30	A1		6.86	6.90	7.10	A1				
	9.30		9.50	E5		7.15		7.35	E5				
10 x 8	9.85		10.20	F4A	x	7.90		8.25	F3A	300	7 5/8 x 11	7	\$659.74
	10.20		10.50	F4B		8.25		8.55	F3B				
	10.60	10.75	10.90	D4		8.55	8.63	8.75	D3				
	11.10	11.10	11.40	B2		8.99	9.05	9.30	A1				
	11.55		11.75	A1		9.30		9.50	E5				
	11.90		12.10	E5									
12 x 10	12.00		12.30	F4A	x	9.85		10.20	F4A	300	8 5/8 x 11	7	\$754.87
	12.30		12.60	F4B		10.20		10.50	F4B				
	12.60	12.75	12.90	D4		10.60	10.75	10.90	D4				
	13.20	13.20	13.60	B2		11.10	11.10	11.40	B2				
	13.80	14.00	14.10	A1		11.55		11.75	A1				
	14.10		14.35	E5		11.90		12.10	E5				
14 x 12	14.60		14.90	F2	x	12.00		12.30	F4A	150	9 5/8 x 11	7	\$1,190.02
	15.30	15.30	15.70	B2		12.30		12.60	F4B				
	15.80	16.00	16.25	A1		12.60	12.75	12.90	D4				
	16.40		16.80	E5		13.20	13.20	13.60	B2				
						13.80	14.00	14.10	A1				
						14.10		14.35	E5				

All dimensions are in inches  
Continued...

Note: \* The high limit of the range is used in the ordering code.

**ROBAR INDUSTRIES LTD.**  
**BC** Phone (604) 591-8811 / 1-800-663-6553  
 Fax (604) 591-5288  
 Email: waterworks@robarindustries.com

**LES PRODUITS INDUSTRIELS ROBAR INC.**  
**QUEBEC** Phone (450) 441-7525 / 1-800-315-9525  
 Fax (450) 441-4894  
 Web www.Robarindustries.com

# 1408R REDUCING COUPLINGS

CAST DUCTILE IRON  
PRICE INFORMATION

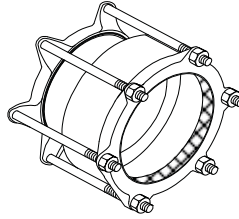

Nom Pipe Size	First End				By X	Second End				MAX. Press. (LBS/IN)	Fasteners No. Dia x Length	Sleeve Length (IN.)	List Price
	Range			End Code		Range			End Code				
	Low	Pipe OD Actual	High*			Low	Pipe OD Actual	High*					
16 x 14					x	14.60		14.90	F2	150	10 5/8 x 11	7	\$ 1,452.79
	17.40	17.40	17.80	B2		15.30	15.30	15.70	B2				
	17.80	18.00	18.20	A1		15.80	16.00	16.25	A1				
	18.40		18.80	E5		16.40		16.80	E5				
18 x 16	18.80		19.20	B1	x	17.40	17.40	17.80	B2	150	12 5/8 x 11	7	\$ 1,812.22
	19.10	19.50	19.70	A2		17.80	18.00	18.20	A1				
	19.70	20.00	20.25	E5		18.40		18.80	E5				
20 x 16	20.80		21.35	B1	x	17.40	17.40	17.80	B2	150	12 5/8 x 11	7	\$ 2,129.46
	21.35	21.60	21.75	A2		17.80	18.00	18.20	A1				
	21.75	22.00	22.25	E5		18.40		18.80	E5				
20 x 18	20.80		21.35	B1	x	18.80		19.20	B1	150	12 5/8 x 11	7	\$ 2,063.55
	21.35	21.60	21.75	A2		19.10	19.50	19.70	A2				
	21.75	22.00	22.25	E5		19.70	20.00	20.25	E5				
22 x 16	22.95		23.35	B1	x	17.40	17.40	17.80	B2	150	13 5/8 x 11	7	\$ 2,394.53
	23.45		23.85	A2		17.80	18.00	18.20	A1				
	23.75	24.00	24.25	E5		18.40		18.80	E5				
22 x 18	22.95		23.35	B1	x	18.80		19.20	B1	150	13 5/8 x 11	7	\$ 2,388.80
	23.45		23.85	A2		19.10	19.50	19.70	A2				
	23.75	24.00	24.25	E5		19.70	20.00	20.25	E5				
22 x 20	22.95		23.35	B1	x	20.80		21.35	B1	150	13 5/8 x 11	7	\$ 2,189.55
	23.45		23.85	A2		21.35	21.60	21.75	A2				
	23.75	24.00	24.25	E5		21.75	22.00	22.25	E5				
24 x 22	25.70	25.80	26.00	A2	x	22.95		23.35	B1	150	14 5/8 x 15	10	\$ 2,600.29
	26.10		26.32	E5		23.45		23.85	A2				
						23.75	24.00	24.25	E5				

All dimensions are in inches

Note: \* The high limit of the range is used in the ordering code.

## ROBAR INDUSTRIES LTD.

BC Phone (604) 591-8811 / 1-800-663-6553  
Fax (604) 591-5288  
Email waterworks@robarindustries.com

## LES PRODUITS INDUSTRIELS ROBAR INC.

QUEBEC Phone (450) 441-7525 / 1-800-315-9525  
Fax (450) 441-4894  
Web www.Robarindustries.com



# 1506R REDUCING COUPLINGS

CAST DUCTILE IRON  
PRICE INFORMATION

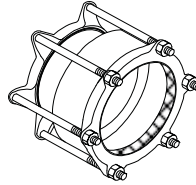

Nom Pipe Size	First End				By X	Second End				MAX. Press. (LBS/IN)	Fasteners No. Dia x Length	Sleeve Length (IN.)	List Price
	Range					Range							
	Low	Pipe OD Actual	High*	End Code		Low	Pipe OD Actual	High*	End Code				
6 x 4	5.85		6.15	F3A	x	3.45	3.50	3.60	4T	300	5 5/8 x 8	5	\$534.49
	6.15		6.45	F3B		3.75		4.05	F3A				
	6.50	6.63	6.70	D3		4.05		4.35	F3B				
	6.86	6.90	7.10	A1		4.40	4.50	4.60	D3				
	7.15		7.35	E5		4.74	4.80	5.10	A1				
						5.10		5.30	E5				
8 x 6	7.90		8.25	F3A	x	5.85		6.15	F3A	300	6 5/8 x 8	5	\$683.52
	8.25		8.55	F3B		6.15		6.45	F3B				
	8.55	8.63	8.75	D3		6.50	6.63	6.70	D3				
	8.99	9.05	9.30	A1		6.86	6.90	7.10	A1				
	9.30		9.50	E5		7.15		7.35	E5				
10 x 8	9.85		10.20	F4A	x	7.90		8.25	F3A	300	7 5/8 x 11	7	\$1,077.20
	10.20		10.50	F4B		8.25		8.55	F3B				
	10.60	10.75	10.90	D4		8.55	8.63	8.75	D3				
	11.10	11.10	11.40	B2		8.99	9.05	9.30	A1				
	11.55		11.75	A1		9.30		9.50	E5				
	11.90		12.10	E5									
12 x 10	12.00		12.30	F4A	x	9.85		10.20	F4A	300	8 5/8 x 11	7	\$1,224.01
	12.30		12.60	F4B		10.20		10.50	F4B				
	12.60	12.75	12.90	D4		10.60	10.75	10.90	D4				
	13.20	13.20	13.60	B2		11.10	11.10	11.40	B2				
	13.80	14.00	14.10	A1		11.55		11.75	A1				
	14.10		14.35	E5		11.90		12.10	E5				
14 x 12	14.60		14.90	F2	x	12.00		12.30	F4A	150	9 5/8 x 11	7	\$1,890.68
	15.30	15.30	15.70	B2		12.30		12.60	F4B				
	15.80	16.00	16.25	A1		12.60	12.75	12.90	D4				
	16.40		16.80	E5		13.20	13.20	13.60	B2				
						13.80	14.00	14.10	A1				
						14.10		14.35	E5				

All dimensions are in inches

Note: \* The high limit of the range is used in the ordering code.

## ROBAR INDUSTRIES LTD.

BC Phone (604) 591-8811 / 1-800-663-6553  
 Fax (604) 591-5288  
 Email: waterworks@robarindustries.com

## LES PRODUITS INDUSTRIELS ROBAR INC.

QUEBEC Phone (450) 441-7525 / 1-800-315-9525  
 Fax (450) 441-4894  
 Web www.Robarindustries.com



# 1506R REDUCING COUPLINGS

CAST DUCTILE IRON  
PRICE INFORMATION

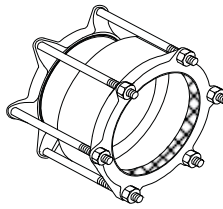

Nom Pipe Size	First End				By X	Second End				MAX. Press. (LBS/IN)	Fasteners No. Dia x Length	Sleeve Length (IN.)	List Price
	Range			End Code		Range			End Code				
	Low	Pipe OD Actual	High*			Low	Pipe OD Actual	High*					
16 x 14					x	14.60		14.90	F2	150	10 5/8 x 11	7	\$ 2,276.40
	17.40	17.40	17.80	B2		15.30	15.30	15.70	B2				
	17.80	18.00	18.20	A1		15.80	16.00	16.25	A1				
	18.40		18.80	E5		16.40		16.80	E5				
18 x 16	18.80		19.20	B1	x	17.40	17.40	17.80	B2	150	12 5/8 x 11	7	\$ 2,897.67
	19.10	19.50	19.70	A2		17.80	18.00	18.20	A1				
	19.70	20.00	20.25	E5		18.40		18.80	E5				
20 x 16	20.80		21.35	B1	x	17.40	17.40	17.80	B2	150	12 5/8 x 11	7	\$ 3,237.72
	21.35	21.60	21.75	A2		17.80	18.00	18.20	A1				
	21.75	22.00	22.25	E5		18.40		18.80	E5				
20 x 18	20.80		21.35	B1	x	18.80		19.20	B1	150	12 5/8 x 11	7	\$ 3,125.96
	21.35	21.60	21.75	A2		19.10	19.50	19.70	A2				
	21.75	22.00	22.25	E5		19.70	20.00	20.25	E5				
22 x 16	22.95		23.35	B1	x	17.40	17.40	17.80	B2	150	13 5/8 x 11	7	\$ 3,660.89
	23.45		23.85	A2		17.80	18.00	18.20	A1				
	23.75	24.00	24.25	E5		18.40		18.80	E5				
22 x 18	22.95		23.35	B1	x	18.80		19.20	B1	150	13 5/8 x 11	7	\$ 3,643.74
	23.45		23.85	A2		19.10	19.50	19.70	A2				
	23.75	24.00	24.25	E5		19.70	20.00	20.25	E5				
22 x 20	22.95		23.35	B1	x	20.80		21.35	B1	150	13 5/8 x 11	7	\$ 3,350.10
	23.45		23.85	A2		21.35	21.60	21.75	A2				
	23.75	24.00	24.25	E5		21.75	22.00	22.25	E5				
24 x 22	25.70	25.80	26.00	A2	x	22.95		23.35	B1	150	14 5/8 x 15	10	\$ 4,337.05
	26.10		26.32	E5		23.45		23.85	A2				
						23.75	24.00	24.25	E5				

All dimensions are in inches

Note: \* The high limit of the range is used in the ordering code.

## ROBAR INDUSTRIES LTD.

BC Phone (604) 591-8811 / 1-800-663-6553  
Fax (604) 591-5288  
Email: waterworks@robarindustries.com

## LES PRODUITS INDUSTRIELS ROBAR INC.

QUEBEC Phone (450) 441-7525 / 1-800-315-9525  
Fax (450) 441-4894  
Web www.Robarindustries.com



# 1507R REDUCING COUPLINGS

CAST DUCTILE IRON

PRICE INFORMATION

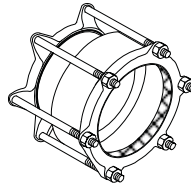

Nom Pipe Size	First End				By X	Second End				MAX. Press. (LBS/IN)	Fasteners No. Dia x Length	Sleeve Length (IN.)	List Price
	Range			End Code		Range			End Code				
	Low	Pipe OD Actual	High*			Low	Pipe OD Actual	High*					
6 x 4	5.85		6.15	F3A	x	3.45	3.50	3.60	4T	300	5 5/8 x 8	5	\$581.02
	6.15		6.45	F3B		3.75		4.05	F3A				
	6.50	6.63	6.70	D3		4.05		4.35	F3B				
	6.86	6.90	7.10	A1		4.40	4.50	4.60	D3				
	7.15		7.35	E5		4.74	4.80	5.10	A1				
						5.10		5.30	E5				
8 x 6	7.90		8.25	F3A	x	5.85		6.15	F3A	300	6 5/8 x 8	5	\$739.38
	8.25		8.55	F3B		6.15		6.45	F3B				
	8.55	8.63	8.75	D3		6.50	6.63	6.70	D3				
	8.99	9.05	9.30	A1		6.86	6.90	7.10	A1				
	9.30		9.50	E5		7.15		7.35	E5				
10 x 8	9.85		10.20	F4A	x	7.90		8.25	F3A	300	7 5/8 x 11	7	\$1,138.79
	10.20		10.50	F4B		8.25		8.55	F3B				
	10.60	10.75	10.90	D4		8.55	8.63	8.75	D3				
	11.10	11.10	11.40	B2		8.99	9.05	9.30	A1				
	11.55		11.75	A1		9.30		9.50	E5				
	11.90		12.10	E5									
12 x 10	12.00		12.30	F4A	x	9.85		10.20	F4A	300	8 5/8 x 11	7	\$1,293.81
	12.30		12.60	F4B		10.20		10.50	F4B				
	12.60	12.75	12.90	D4		10.60	10.75	10.90	D4				
	13.20	13.20	13.60	B2		11.10	11.10	11.40	B2				
	13.80	14.00	14.10	A1		11.55		11.75	A1				
	14.10		14.35	E5		11.90		12.10	E5				
14 x 12	14.60		14.90	F2	x	12.00		12.30	F4A	150	9 5/8 x 11	7	\$1,969.12
	15.30	15.30	15.70	B2		12.30		12.60	F4B				
	15.80	16.00	16.25	A1		12.60	12.75	12.90	D4				
	16.40		16.80	E5		13.20	13.20	13.60	B2				
						13.80	14.00	14.10	A1				
						14.10		14.35	E5				

All dimensions are in inches

Note: \* The high limit of the range is used in the ordering code.

## ROBAR INDUSTRIES LTD.

BC Phone (604) 591-8811 / 1-800-663-6553  
 Fax (604) 591-5288  
 Email: waterworks@robarindustries.com

## LES PRODUITS INDUSTRIELS ROBAR INC.

QUEBEC Phone (450) 441-7525 / 1-800-315-9525  
 Fax (450) 441-4894  
 Web www.Robarindustries.com



# 1507R REDUCING COUPLINGS

CAST DUCTILE IRON  
PRICE INFORMATION

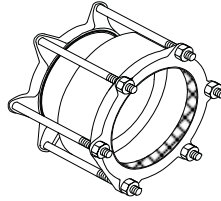

Nom Pipe Size	FIRST END				By X	SECOND END				MAX. PRESS. (LBS/IN <sup>2</sup> )	Fasteners No. Dia x Length	Sleeve Length (IN.)	List Price
	RANGE					RANGE							
	Low	Pipe OD Actual	High*	End Code		Low	Pipe OD Actual	High*	End Code				
16 x 14					x	14.60		14.90	F2	150	10 5/8 x 11	7	\$ 2,371.14
	17.40	17.40	17.80	B2		15.30	15.30	15.70	B2				
	17.80	18.00	18.20	A1		15.80	16.00	16.25	A1				
	18.40		18.80	E5		16.40		16.80	E5				
18 x 16	18.80		19.20	B1	x	17.40	17.40	17.80	B2	150	12 5/8 x 11	7	\$ 2,920.28
	19.10	19.50	19.70	A2		17.80	18.00	18.20	A1				
	19.70	20.00	20.25	E5		18.40		18.80	E5				
20 x 16	20.80		21.35	B1	x	17.40	17.40	17.80	B2	150	12 5/8 x 11	7	\$ 3,351.45
	21.35	21.60	21.75	A2		17.80	18.00	18.20	A1				
	21.75	22.00	22.25	E5		18.40		18.80	E5				
20 x 18	20.80		21.35	B1	x	18.80		19.20	B1	150	12 5/8 x 11	7	\$ 3,239.64
	21.35	21.60	21.75	A2		19.10	19.50	19.70	A2				
	21.75	22.00	22.25	E5		19.70	20.00	20.25	E5				
22 x 16	22.95		23.35	B1	x	17.40	17.40	17.80	B2	150	13 5/8 x 11	7	\$ 3,784.07
	23.45		23.85	A2		17.80	18.00	18.20	A1				
	23.75	24.00	24.25	E5		18.40		18.80	E5				
22 x 18	22.95		23.35	B1	x	18.80		19.20	B1	150	13 5/8 x 11	7	\$ 3,766.93
	23.45		23.85	A2		19.10	19.50	19.70	A2				
	23.75	24.00	24.25	E5		19.70	20.00	20.25	E5				
22 x 20	22.95		23.35	B1	x	20.80		21.35	B1	150	13 5/8 x 11	7	\$ 3,451.54
	23.45		23.85	A2		21.35	21.60	21.75	A2				
	23.75	24.00	24.25	E5		21.75	22.00	22.25	E5				
24 x 22	25.70	25.80	26.00	A2	x	22.95		23.35	B1	150	14 5/8 x 15	10	\$ 4,088.15
	26.10		26.32	E5		23.45		23.85	A2				
						23.75	24.00	24.25	E5				

All dimensions are in inches

Note: \* The high limit of the range is used in the ordering code.

## ROBAR INDUSTRIES LTD.

BC Phone (604) 591-8811 / 1-800-663-6553  
Fax (604) 591-5288  
Email: waterworks@robarindustries.com

## LES PRODUITS INDUSTRIELS ROBAR INC.

QUEBEC Phone (450) 441-7525 / 1-800-315-9525  
Fax (450) 441-4894  
Web www.Robarindustries.com



# 1508R REDUCING COUPLINGS

CAST DUCTILE IRON  
PRICE INFORMATION

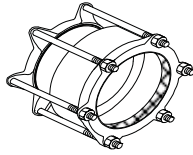

Nom Pipe Size	First End				By X	Second End				MAX. Press. (LBS/IN)	Fasteners No. Dia x Length	Sleeve Length (IN.)	List Price
	Range			End Code		Range			End Code				
	Low	Pipe OD Actual	High*			Low	Pipe OD Actual	High*					
6 x 4	5.85		6.15	F3A	x	3.45	3.50	3.60	4T	300	5 5/8 x 8	5	\$431.59
	6.15		6.45	F3B		3.75		4.05	F3A				
	6.50	6.63	6.70	D3		4.05		4.35	F3B				
	6.86	6.90	6.70	A1		4.40	4.50	4.60	D3				
	7.15		7.35	E5		4.74	4.80	5.10	A1				
						5.10		5.30	E5				
8 x 6	7.90		8.25	F3A	x	5.85		6.15	F3A	300	6 5/8 x 8	5	\$558.61
	8.25		8.55	F3B		6.15		6.45	F3B				
	8.55	8.63	8.75	D3		6.50	6.63	6.70	D3				
	8.99	9.05	9.30	A1		6.86	6.90	6.70	A1				
	9.30		9.50	E5		7.15		7.35	E5				
10 x 8	9.85		10.20	F4A	x	7.90		8.25	F3A	300	7 5/8 x 11	7	\$916.99
	10.20		10.50	F4B		8.25		8.55	F3B				
	10.60	10.75	10.90	D4		8.55	8.63	8.75	D3				
	11.10	11.10	11.40	B2		8.99	9.05	9.30	A1				
	11.55		11.75	A1		9.30		9.50	E5				
	11.90		12.10	E5									
12 x 10	12.00		12.30	F4A	x	9.85		10.20	F4A	300	8 5/8 x 11	7	\$1,039.83
	12.30		12.60	F4B		10.20		10.50	F4B				
	12.60	12.75	12.90	D4		10.60	10.75	10.90	D4				
	13.20	13.20	13.60	B2		11.10	11.10	11.40	B2				
	13.80	14.00	14.10	A1		11.55		11.75	A1				
	14.10		14.35	E5		11.90		12.10	E5				
14 x 12	14.60		14.90	F2	x	12.00		12.30	F4A	150	9 5/8 x 11	7	\$1,665.73
	15.30	15.30	15.70	B2		12.30		12.60	F4B				
	15.80	16.00	16.25	A1		12.60	12.75	12.90	D4				
	16.40		16.80	E5		13.20	13.20	13.60	B2				
						13.80	14.00	14.10	A1				
						14.10		14.35	E5				

All dimensions are in inches  
Continued....

Note: \* The high limit of the range is used in the ordering code.

## ROBAR INDUSTRIES LTD.

BC Phone (604) 591-8811 / 1-800-663-6553  
Fax (604) 591-5288  
Email: waterworks@robarindustries.com

## LES PRODUITS INDUSTRIELS ROBAR INC.

QUEBEC Phone (450) 441-7525 / 1-800-315-9525  
Fax (450) 441-4894  
Web www.Robarindustries.com



# 1508R REDUCING COUPLINGS

CAST DUCTILE IRON  
PRICE INFORMATION

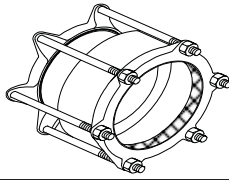

Nom Pipe Size	First End				By X	Second End				MAX. Press. (LBS/IN)	Fasteners No. Dia x Length	Sleeve Length (IN.)	List Price
	Range					Range							
	Low	Pipe OD Actual	High*	End Code		Low	Pipe OD Actual	High*	End Code				
16 x 14					x	14.60		14.90	F2	150	10 5/8 x 11	7	\$ 2,003.93
	17.40	17.40	17.80	B2		15.30	15.30	15.70	B2				
	17.80	18.00	18.20	A1		15.80	16.00	16.25	A1				
	18.40		18.80	E5		16.40		16.80	E5				
18 x 16	18.80		19.20	B1	x	17.40	17.40	17.80	B2	150	12 5/8 x 11	7	\$ 2,564.24
	19.10	19.50	19.70	A2		17.80	18.00	18.20	A1				
	19.70	20.00	20.25	E5		18.40		18.80	E5				
20 x 16	20.80		21.35	B1	x	17.40	17.40	17.80	B2	150	12 5/8 x 11	7	\$ 2,894.01
	21.35	21.60	21.75	A2		17.80	18.00	18.20	A1				
	21.75	22.00	22.25	E5		18.40		18.80	E5				
20 x 18	20.80		21.35	B1	x	18.80		19.20	B1	150	12 5/8 x 11	7	\$ 2,784.64
	21.35	21.60	21.75	A2		19.10	19.50	19.70	A2				
	21.75	22.00	22.25	E5		19.70	20.00	20.25	E5				
22 x 16	22.95		23.35	B1	x	17.40	17.40	17.80	B2	150	13 5/8 x 11	7	\$ 3,282.68
	23.45		23.85	A2		17.80	18.00	18.20	A1				
	23.75	24.00	24.25	E5		18.40		18.80	E5				
22 x 18	22.95		23.35	B1	x	18.80		19.20	B1	150	13 5/8 x 11	7	\$ 3,265.86
	23.45		23.85	A2		19.10	19.50	19.70	A2				
	23.75	24.00	24.25	E5		19.70	20.00	20.25	E5				
22 x 20	22.95		23.35	B1	x	20.80		21.35	B1	150	13 5/8 x 11	7	\$ 2,983.19
	23.45		23.85	A2		21.35	21.60	21.75	A2				
	23.75	24.00	24.25	E5		21.75	22.00	22.25	E5				
24 x 22	25.70	25.80	26.00	A2	x	22.95		23.35	B1	150	14 5/8 x 15	10	\$ 3,516.56
	26.10		26.32	E5		23.45		23.85	A2				
						23.75	24.00	24.25	E5				

All dimensions are in inches

Note: \* The high limit of the range is used in the ordering code.

**ROBAR INDUSTRIES LTD.**  
**BC** Phone (604) 591-8811 / 1-800-663-6553  
 Fax (604) 591-5288  
 Email: waterworks@robarindustries.com

**LES PRODUITS INDUSTRIELS ROBAR INC.**  
**QUEBEC** Phone (450) 441-7525 / 1-800-315-9525  
 Fax (450) 441-4894  
 Web www.Robardindustries.com



# 1519R REDUCING COUPLINGS

CAST DUCTILE IRON  
PRICE INFORMATION

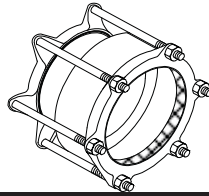

Nom Pipe Size	First End				By X	Second End				MAX. Press. (LBS/IN)	Fasteners No. Dia x Length	Sleeve Length (IN.)	List Price
	Range			End Code		Range			End Code				
	Low	Pipe OD Actual	High*			Low	Pipe OD Actual	High*					
6 x 4	5.85		6.15	F3A	x	3.45	3.50	3.60	4T	300	5 5/8 x 8	5	\$488.17
	6.15		6.45	F3B		3.75		4.05	F3A				
	6.50	6.63	6.70	D3		4.05		4.35	F3B				
	6.86	6.90	6.70	A1		4.40	4.50	4.60	D3				
	7.15		7.35	E5		4.74	4.80	5.10	A1				
						5.10		5.30	E5				
8 x 6	7.90		8.25	F3A	x	5.85		6.15	F3A	300	6 5/8 x 8	5	\$626.50
	8.25		8.55	F3B		6.15		6.45	F3B				
	8.55	8.63	8.75	D3		6.50	6.63	6.70	D3				
	8.99	9.05	9.30	A1		6.86	6.90	6.70	A1				
	9.30		9.50	E5		7.15		7.35	E5				
10 x 8	9.85		10.20	F4A	x	7.90		8.25	F3A	300	7 5/8 x 11	7	\$1,005.48
	10.20		10.50	F4B		8.25		8.55	F3B				
	10.60	10.75	10.90	D4		8.55	8.63	8.75	D3				
	11.10	11.10	11.40	B2		8.99	9.05	9.30	A1				
	11.55		11.75	A1		9.30		9.50	E5				
	11.90		12.10	E5									
12 x 10	12.00		12.30	F4A	x	9.85		10.20	F4A	300	8 5/8 x 11	7	\$1,133.60
	12.30		12.60	F4B		10.20		10.50	F4B				
	12.60	12.75	12.90	D4		10.60	10.75	10.90	D4				
	13.20	13.20	13.60	B2		11.10	11.10	11.40	B2				
	13.80	14.00	14.10	A1		11.55		11.75	A1				
	14.10		14.35	E5		11.90		12.10	E5				
14 x 12	14.60		14.90	F2	x	12.00		12.30	F4A	150	9 5/8 x 11	7	\$1,788.66
	15.30	15.30	15.70	B2		12.30		12.60	F4B				
	15.80	16.00	16.25	A1		12.60	12.75	12.90	D4				
	16.40		16.80	E5		13.20	13.20	13.60	B2				
						13.80	14.00	14.10	A1				
						14.10		14.35	E5				

All dimensions are in inches  
Continued....

Note: \* The high limit of the range is used in the ordering code.

## ROBAR INDUSTRIES LTD.

BC Phone (604) 591-8811 / 1-800-663-6553  
Fax (604) 591-5288  
Email: waterworks@robarindustries.com

## LES PRODUITS INDUSTRIELS ROBAR INC.

QUEBEC Phone (450) 441-7525 / 1-800-315-9525  
Fax (450) 441-4894  
Web www.Robarindustries.com

# 1519R REDUCING COUPLINGS

CAST DUCTILE IRON  
PRICE INFORMATION

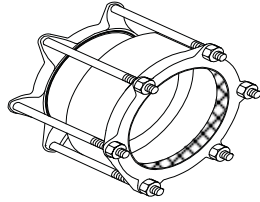

Nom Pipe Size	First End				By X	Second End				MAX. Press. (LBS/IN)	Fasteners No. Dia x Length	Sleeve Length (IN.)	List Price
	Range			End Code		Range			End Code				
	Low	Pipe OD Actual	High*			Low	Pipe OD Actual	High*					
16 x 14						14.60		14.90	F2	150	10 5/8 x 11	7	\$ 2,153.33
	17.40	17.40	17.80	B2	x	15.30	15.30	15.70	B2				
	17.80	18.00	18.20	A1		15.80	16.00	16.25	A1				
	18.40		18.80	E5		16.40		16.80	E5				
18 x 16	18.80		19.20	B1		17.40	17.40	17.80	B2	150	12 5/8 x 11	7	\$ 2,659.19
	19.10	19.50	19.70	A2	x	17.80	18.00	18.20	A1				
	19.70	20.00	20.25	E5		18.40		18.80	E5				
20 x 16	20.80		21.35	B1		17.40	17.40	17.80	B2	150	12 5/8 x 11	7	\$ 3,090.36
	21.35	21.60	21.75	A2	x	17.80	18.00	18.20	A1				
	21.75	22.00	22.25	E5		18.40		18.80	E5				
20 x 18	20.80		21.35	B1		18.80		19.20	B1	150	12 5/8 x 11	7	\$ 2,986.64
	21.35	21.60	21.75	A2	x	19.10	19.50	19.70	A2				
	21.75	22.00	22.25	E5		19.70	20.00	20.25	E5				
22 x 16	22.95		23.35	B1		17.40	17.40	17.80	B2	150	13 5/8 x 11	7	\$ 3,509.29
	23.45		23.85	A2	x	17.80	18.00	18.20	A1				
	23.75	24.00	24.25	E5		18.40		18.80	E5				
22 x 18	22.95		23.35	B1		18.80		19.20	B1	150	13 5/8 x 11	7	\$ 3,492.19
	23.45		23.85	A2	x	19.10	19.50	19.70	A2				
	23.75	24.00	24.25	E5		19.70	20.00	20.25	E5				
22 x 20	22.95		23.35	B1		20.80		21.35	B1	150	13 5/8 x 11	7	\$ 3,176.56
	23.45		23.85	A2	x	21.35	21.60	21.75	A2				
	23.75	24.00	24.25	E5		21.75	22.00	22.25	E5				
24 x 22	25.70	25.80	26.00	A2		22.95		23.35	B1	150	14 5/8 x 15	10	\$ 3,791.57
	26.10		26.32	E5	x	23.45		23.85	A2				
						23.75	24.00	24.25	E5				

All dimensions are in inches

Note: \* The high limit of the range is used in the ordering code.

**ROBAR INDUSTRIES LTD.**

BC Phone (604) 591-8811 / 1-800-663-6553  
 Fax (604) 591-5288  
 Email: waterworks@robarindustries.com

**LES PRODUITS INDUSTRIELS ROBAR INC.**

QUEBEC Phone (450) 441-7525 / 1-800-315-9525  
 Fax (450) 441-4894  
 Web www.Robarindustries.com





# 1406 & 1408 COUPLING COMPONENTS

## PRICE INFORMATION

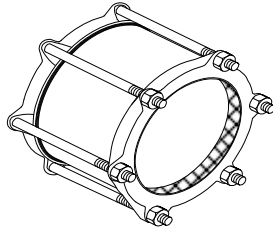

Nominal Pipe Size	Center Sleeve Description	Center Sleeve Length	Center Sleeve Price	End Ring Price	Gasket Price
4	Standard	5"	\$ 44.81	\$ 22.15	\$ 11.29
	Long Body	7"	\$ 71.86	\$ 22.15	\$ 11.29
6	Standard	5"	\$ 77.03	\$ 31.49	\$ 13.71
	Long Body	7"	\$ 108.13	\$ 31.49	\$ 13.71
8	Standard	5"	\$ 80.68	\$ 47.34	\$ 21.04
	Long Body	7"	\$ 121.43	\$ 47.34	\$ 21.04
10	Standard	7"	\$ 226.24	\$ 73.91	\$ 28.70
	G8 and S9	7"	\$ 166.38	\$ 68.03	\$ 22.60
12	Standard	7"	\$ 238.19	\$ 84.71	\$ 41.69
	G8 and S9	7"	\$ 175.62	\$ 72.79	\$ 32.34
14	Standard	7"	\$ 412.56	\$ 155.27	\$ 87.60
16	Standard	7"	\$ 452.95	\$ 190.10	\$ 92.17
18	Standard	7"	\$ 620.68	\$ 257.83	\$ 105.56
20	Standard	7"	\$ 770.17	\$ 350.41	\$ 109.44
22	Standard	7"	\$ 924.07	\$ 363.51	\$ 111.71
24	Standard	10"	\$ 944.92	\$ 417.94	\$ 124.56

Note: For Fasteners Prices see page 1 - 31

### ROBAR INDUSTRIES LTD.

**BC** Phone (604) 591-8811 / 1-800-663-6553  
Fax (604) 591-5288  
Email [waterworks@robarindustries.com](mailto:waterworks@robarindustries.com)

### LES PRODUITS INDUSTRIELS ROBAR INC.

**QUEBEC** Phone (450) 441-7525 / 1-800-315-9525  
Fax (450) 441-4894  
Web [www.Robarindustries.com](http://www.Robarindustries.com)



# 1506 & 1508 COUPLING COMPONENTS

## PRICE INFORMATION

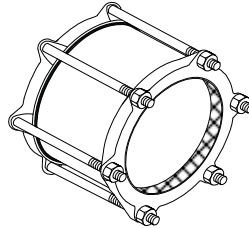

Nominal Pipe Size	Center Sleeve Description	Center Sleeve Length	Center Sleeve Price	End Ring Price	Gasket Price
4	Standard	5"	\$ 71.65	\$ 35.36	\$ 11.29
	Long Body	7"	\$ 115.00	\$ 35.36	\$ 11.29
6	Standard	5"	\$ 123.20	\$ 50.34	\$ 13.70
	Long Body	7"	\$ 173.02	\$ 50.34	\$ 13.70
8	Standard	5"	\$ 129.02	\$ 75.76	\$ 21.05
	Long Body	7"	\$ 194.24	\$ 75.76	\$ 21.05
10	Standard	7"	\$ 316.73	\$ 86.26	\$ 28.70
	G8 and S9	7"	\$ 241.24	\$ 98.68	\$ 22.61
12	Standard	7"	\$ 333.43	\$ 118.66	\$ 41.69
	G8 and S9	7"	\$ 254.59	\$ 105.60	\$ 32.34
14	Standard	7"	\$ 618.85	\$ 232.86	\$ 87.60
16	Standard	7"	\$ 656.80	\$ 275.62	\$ 92.17
18	Standard	7"	\$ 806.93	\$ 335.18	\$ 105.56
20	Standard	7"	\$ 924.14	\$ 420.43	\$ 109.44
22	Standard	7"	\$ 1,108.91	\$ 435.89	\$ 111.71
24	Standard	10"	\$ 1,133.96	\$ 500.26	\$ 124.56

Note: For Fasteners Prices see page 1 - 31

### ROBAR INDUSTRIES LTD.

BC Phone (604) 591-8811 / 1-800-663-6553  
 Fax (604) 591-5288  
 Email waterworks@robarindustries.com

### LES PRODUITS INDUSTRIELS ROBAR INC.

QUEBEC Phone (450) 441-7525 / 1-800-315-9525  
 Fax (450) 441-4894  
 Web www.Robarindustries.com



# 1507 & 1519 COUPLING COMPONENTS

## PRICE INFORMATION

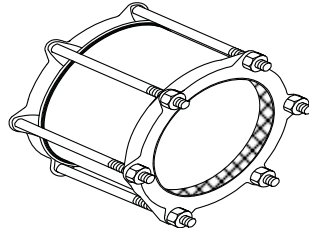

Nominal Pipe Size	Center Sleeve Description	Center Sleeve Length	1507 Center Sleeve Price	1519 Center Sleeve Price	End Ring Price	Gasket Price
4	Standard	5"	\$ 71.66	\$ 78.94	\$ 38.88	\$ 11.29
	Long Body	7"	\$ 115.00	\$ 122.23	\$ 38.88	\$ 11.29
6	Standard	5"	\$ 123.20	\$ 130.49	\$ 54.72	\$ 13.71
	Long Body	7"	\$ 173.01	\$ 180.26	\$ 54.72	\$ 13.71
8	Standard	5"	\$ 129.02	\$ 144.99	\$ 80.89	\$ 21.04
	Long Body	7"	\$ 194.24	\$ 162.77	\$ 80.89	\$ 21.04
10	Standard	7"	\$ 316.73	\$ 324.01	\$ 109.56	\$ 28.70
	G8 and S9	7"	\$ 241.24	\$ 248.47	\$ 104.77	\$ 22.61
12	Standard	7"	\$ 333.43	\$ 340.68	\$ 125.61	\$ 41.69
	G8 and S9	7"	\$ 254.60	\$ 261.89	\$ 112.52	\$ 32.34
14	Standard	7"	\$ 618.85	\$ 626.71	\$ 241.38	\$ 87.60
16	Standard	7"	\$ 656.80	\$ 664.68	\$ 285.09	\$ 92.17
18	Standard	7"	\$ 806.93	\$ 814.77	\$ 346.54	\$ 105.56
20	Standard	7"	\$ 924.15	\$ 932.03	\$ 431.84	\$ 109.44
22	Standard	7"	\$ 1,108.91	\$ 1,116.81	\$ 448.14	\$ 111.71
24	Standard	10"	\$ 1,133.96	\$ 1,141.80	\$ 514.74	\$ 124.56

Note: For Fasteners Prices see page 1 - 31

### ROBAR INDUSTRIES LTD.

BC Phone (604) 591-8811 / 1-800-663-6553  
 Fax (604) 591-5288  
 Email waterworks@robarindustries.com

### LES PRODUITS INDUSTRIELS ROBAR INC

QUEBEC Phone (450) 441-7525/1-800-315-9525  
 Fax (450) 441-4894  
 Web www.Robarindustries.com

# 1406R and 1408R REDUCING COUPLING COMPONENTS

PRICE INFORMATION

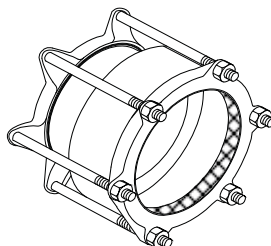

Nominal Pipe Size	Center Sleeve Description	Center Sleeve Price	Large End Ring Price	Small End Ring Price	Large Gasket Price	Small Gasket Price
6 x 4	6" Standard x 4" Standard	\$ 102.35	\$ 31.49	\$ 94.46	\$ 13.71	\$ 11.29
8 x 6	8" Standard x 6" Standard	\$ 136.91	\$ 47.34	\$ 112.25	\$ 21.04	\$ 13.71
10 x 8	10" Steel x 8" Standard	\$ 290.48	\$ 73.91	\$ 148.63	\$ 28.70	\$ 21.04
	10" Standard x 8" Standard	\$ 290.48	\$ 73.91	\$ 148.63	\$ 28.70	\$ 21.04
10 x 10	10" Standard x 10" Steel	\$ 226.23	\$ 73.91	\$ 73.91	\$ 28.70	\$ 28.70
12 x 10	12" Steel x 10" Steel	\$ 331.56	\$ 84.71	\$ 157.20	\$ 41.69	\$ 28.70
	12" Steel x 10" Standard	\$ 331.56	\$ 84.71	\$ 157.20	\$ 41.69	\$ 28.70
	12" Standard x 10" Steel	\$ 331.56	\$ 84.71	\$ 157.20	\$ 41.69	\$ 28.70
	12" Standard x 10" Standard	\$ 331.56	\$ 84.71	\$ 157.20	\$ 41.69	\$ 28.70
12 x 12	12" Standard x 12" Steel	\$ 238.19	\$ 84.71	\$ 84.71	\$ 41.69	\$ 41.69
14 x 12	14" Standard x 12" Standard	\$ 529.05	\$ 155.27	\$ 255.02	\$ 87.60	\$ 41.69
16 x 14	16" Standard x 14" Standard	\$ 595.09	\$ 190.10	\$ 317.09	\$ 92.17	\$ 87.60
18 x 16	18" Standard x 16" Standard	\$ 799.32	\$ 257.83	\$ 349.25	\$ 105.56	\$ 92.17
20 x 16	20" Standard x 16" Standard	\$ 949.75	\$ 350.41	\$ 404.64	\$ 109.44	\$ 92.17
20 x 18	20" Standard x 18" Standard	\$ 883.11	\$ 350.41	\$ 395.92	\$ 109.44	\$ 105.56
22 x 16	22" Standard x 16" Standard	\$ 1,180.49	\$ 363.51	\$ 401.26	\$ 109.44	\$ 92.17
22 x 18	22" Standard x 18" Standard	\$ 1,148.02	\$ 363.51	\$ 414.96	\$ 111.71	\$ 105.56
22 x 20	22" Standard x 20" Standard	\$ 918.39	\$ 363.51	\$ 414.96	\$ 111.71	\$ 109.44
24 x 22	24" Standard x 22" Standard	\$ 1,059.79	\$ 417.93	\$ 569.19	\$ 124.56	\$ 111.71

Note: For Fasteners Prices see page 1 - 31

## ROBAR INDUSTRIES LTD.

BC

Phone (604) 591-8811 / 1-800-663-6553  
 Fax (604) 591-5288  
 Email: waterworks@robarindustries.com

## LES PRODUITS INDUSTRIELS ROBAR INC.

QUEBEC

Phone (450) 441-7525 / 1-800-315-9525  
 Fax (450) 441-4894  
 Web www.Robarindustries.com



# 1506R and 1508R REDUCING COUPLING COMPONENTS PRICE INFORMATION

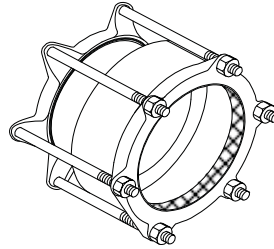

Nominal Pipe Size	Center Sleeve Description	Center Sleeve Price	Large End Ring Price	Small End Ring Price	Large Gasket Price	Small Gasket Price
6 x 4	6" Standard x 4" Standard	\$ 163.75	\$ 50.34	\$ 160.13	\$ 13.71	\$ 11.29
8 x 6	8" Standard x 6" Standard	\$ 219.09	\$ 75.84	\$ 185.01	\$ 21.04	\$ 13.71
10 x 8	10" Steel x 8" Standard	\$ 464.76	\$ 103.51	\$ 244.87	\$ 28.70	\$ 21.04
	10" Standard x 8" Standard	\$ 464.76	\$ 103.51	\$ 244.87	\$ 28.70	\$ 21.04
10 x 10	10" Standard x 10" Steel	\$ 316.73	\$ 103.51	\$ 106.62	\$ 28.70	\$ 28.70
12 x 10	12" Steel x 10" Steel	\$ 530.47	\$ 118.65	\$ 264.06	\$ 41.69	\$ 28.70
	12" Steel x 10" Standard	\$ 530.47	\$ 118.65	\$ 259.12	\$ 41.69	\$ 28.70
	12" Standard x 10" Steel	\$ 530.47	\$ 118.65	\$ 259.12	\$ 41.69	\$ 28.70
	12" Standard x 10" Standard	\$ 530.47	\$ 118.65	\$ 259.12	\$ 41.69	\$ 28.70
12 x 12	12" Standard x 12" Steel	\$ 333.43	\$ 118.65	\$ 122.23	\$ 41.69	\$ 41.69
14 x 12	14" Standard x 12" Standard	\$ 832.23	\$ 232.86	\$ 420.29	\$ 87.60	\$ 41.69
16 x 14	16" Standard x 14" Standard	\$ 952.07	\$ 275.61	\$ 522.61	\$ 92.17	\$ 87.60
18 x 16	18" Standard x 16" Standard	\$ 1,278.95	\$ 335.19	\$ 575.58	\$ 105.56	\$ 92.17
20 x 16	20" Standard x 16" Standard	\$ 1,519.61	\$ 420.44	\$ 666.80	\$ 109.44	\$ 92.17
20 x 18	20" Standard x 18" Standard	\$ 1,411.62	\$ 420.44	\$ 652.53	\$ 109.44	\$ 105.56
22 x 16	22" Standard x 16" Standard	\$ 1,888.74	\$ 435.88	\$ 661.26	\$ 109.44	\$ 92.17
22 x 18	22" Standard x 18" Standard	\$ 1,836.85	\$ 435.88	\$ 683.87	\$ 111.71	\$ 105.56
22 x 20	22" Standard x 20" Standard	\$ 1,469.39	\$ 435.88	\$ 764.58	\$ 111.71	\$ 109.44
24 x 22	24" Standard x 22" Standard	\$ 1,695.68	\$ 500.02	\$ 938.01	\$ 124.56	\$ 111.71

Note: For Fasteners Prices see page 1 - 31

**ROBAR INDUSTRIES LTD.**

**BC** Phone (604) 591-8811 / 1-800-663-6553  
 Fax (604) 591-5288  
 Email: waterworks@robarindustries.com

**LES PRODUITS INDUSTRIELS ROBAR INC.**

**QUEBEC** Phone (450) 441-7525 / 1-800-315-9525  
 Fax (450) 441-4894  
 Web: www.Robarindustries.com

# 1507R / 1519R

## REDUCING COUPLING COMPONENTS

### PRICE INFORMATION

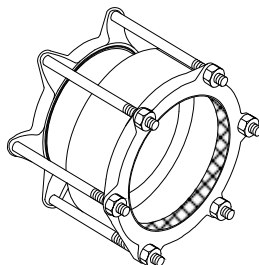

Nominal Pipe Size	Center Sleeve Description	Center Sleeve Price	Large End Ring Price	Small End Ring Price	Large Gasket Price	Small Gasket Price
6 x 4	6" Standard x 4" Standard	\$ 163.76	\$ 50.34	\$ 160.15	\$ 13.71	\$ 11.29
8 x 6	8" Standard x 6" Standard	\$ 219.09	\$ 75.84	\$ 184.99	\$ 21.04	\$ 13.71
10 x 8	10" Steel x 8" Standard	\$ 464.76	\$ 103.51	\$ 244.87	\$ 28.70	\$ 21.04
	10" Standard x 8" Standard	\$ 464.76	\$ 103.51	\$ 244.87	\$ 28.70	\$ 21.04
10 x 10	10" Standard x 10" Steel	\$ 316.73	\$ 103.51	\$ 106.62	\$ 28.70	\$ 28.70
12 x 10	12" Steel x 10" Steel	\$ 530.47	\$ 118.65	\$ 264.05	\$ 41.69	\$ 28.70
	12" Steel x 10" Standard	\$ 530.47	\$ 118.65	\$ 259.11	\$ 41.69	\$ 28.70
	12" Standard x 10" Steel	\$ 530.47	\$ 118.65	\$ 259.11	\$ 41.69	\$ 28.70
	12" Standard x 10" Standard	\$ 530.47	\$ 118.65	\$ 259.11	\$ 41.69	\$ 28.70
12 x 12	12" Standard x 12" Steel	\$ 333.43	\$ 118.65	\$ 122.23	\$ 41.69	\$ 41.69
14 x 12	14" Standard x 12" Standard	\$ 832.23	\$ 232.86	\$ 420.29	\$ 87.60	\$ 41.69
16 x 14	16" Standard x 14" Standard	\$ 952.06	\$ 275.61	\$ 522.62	\$ 92.17	\$ 87.60
18 x 16	18" Standard x 16" Standard	\$ 1,278.95	\$ 335.20	\$ 575.58	\$ 105.56	\$ 92.17
20 x 16	20" Standard x 16" Standard	\$ 1,519.61	\$ 420.44	\$ 666.80	\$ 109.44	\$ 92.17
20 x 18	20" Standard x 18" Standard	\$ 1,411.62	\$ 420.44	\$ 683.87	\$ 109.44	\$ 105.56
22 x 16	22" Standard x 16" Standard	\$ 1,888.74	\$ 435.87	\$ 661.26	\$ 109.44	\$ 92.17
22 x 18	22" Standard x 18" Standard	\$ 1,836.85	\$ 435.87	\$ 569.89	\$ 111.71	\$ 105.56
22 x 20	22" Standard x 20" Standard	\$ 1,469.39	\$ 435.87	\$ 764.58	\$ 111.71	\$ 109.44
24 x 20	24" Standard x 22" Standard	\$ 1,695.68	\$ 500.02	\$ 939.36	\$ 124.56	\$ 111.71

Note: For Fasteners Prices see page 1 - 31

#### ROBAR INDUSTRIES LTD.

**BC** Phone (604) 591-8811 / 1-800-663-6553  
 Fax (604) 591-5288  
 Email: waterworks@robarindustries.com

#### LES PRODUITS INDUSTRIELS ROBAR INC.

**QUEBEC** Phone (450) 441-7525 / 1-800-315-9525  
 Fax (450) 441-4894  
 Web: www.Robarindustries.com



# 1406, 1408, 1506, 1507, 1508 & 1519 FASTENERS PRICE INFORMATION

## 1406 & 1506 Coupling Fasteners - T-304 Stainless Steel

Description	Price
5/8" NC x 8" SS TRACKHEAD BOLTS	\$ 21.21
5/8" NC x 11" SS TRACKHEAD BOLTS	\$ 22.52
5/8" NC x 12" SS TRACKHEAD BOLTS	\$ 24.56
5/8" NC x 14" SS TRACKHEAD BOLTS	\$ 31.22
5/8" NC x 15" SS TRACKHEAD BOLTS	\$ 33.45
5/8" NC x 18" SS TRACKHEAD BOLTS	\$ 40.15
5/8" NC SS HEAVY HEX NUTS	\$ 2.61
5/8" SS WASHERS	\$ 0.67

## 1408 & 1508 Coupling Fasteners - Low Alloy Steel

Description	Price
5/8" NC x 8" TRACKHEAD BOLTS	\$ 7.53
5/8" NC x 11" TRACKHEAD BOLTS	\$ 8.08
5/8" NC x 12" TRACKHEAD BOLTS	\$ 8.81
5/8" NC x 14" TRACKHEAD BOLTS	\$ 11.42
5/8" NC x 15" TRACKHEAD BOLTS	\$ 12.23
5/8" NC x 18" TRACKHEAD BOLTS	\$ 14.69
5/8" NC HEAVY HEX NUTS	\$ 1.08

## 1507 & 1519 Coupling Fasteners - Epoxy Coated Low Alloy Steel

Description	Price
5/8" NC x 8" COATED TRACKHEAD BOLTS	\$ 12.10
5/8" NC x 11" COATED TRACKHEAD BOLTS	\$ 14.88
5/8" NC x 14" COATED TRACKHEAD BOLTS	\$ 20.17
ANODES 300G	\$ 16.87
3/4" x 9" T-304 SS TAPPING SLEEVE BOLTS	\$ 38.22
3/4" SS HEAVY HEX NUT	\$ 4.70
3/4" SS WASHER	\$ 1.65
3/4" x 9" MILD STEEL TAPPING SLEEVE BOLTS	\$ 12.88
3/4" MILD STEEL HEAVY HEX NUT	\$ 1.78

### ROBAR INDUSTRIES LTD.

BC Phone (604) 591-8811 / 1-800-663-6553  
Fax (604) 591-5288  
Email: waterworks@robarindustries.com

### LES PRODUITS INDUSTRIELS ROBAR INC.

QUEBEC Phone (450) 441-7525 / 1-800-315-9525  
Fax (450) 441-4894  
Web: www.Robarindustries.com



# 2 Bolt All Stainless Steel Coupling

## 1696-2B

### PRICING INFORMATION

#### 1696 - 2B Coupling

Nominal Size	Weight Lbs.	List Price
4"	17	\$ 583.01
6"	21	\$ 675.99
8"	25	\$ 814.73
10"	41	\$ 1,192.58
10"OS	44	\$ 1,287.50
12"	46	\$ 1,351.98
12"OS	51	\$ 1,500.00



#### The 2 Bolt Coupling Working Range

Nominal Size	Overall Range	Inner Gasket Range	Outer Gasket Range
4"	4.46 - 5.63	4.46 - 5.03	4.97 - 5.63
6"	6.56 - 7.63	6.56 - 7.13	7.07 - 7.63
8"	8.54 - 9.84	8.54 - 9.17	9.13 - 9.84
10"	10.70 - 11.90	10.70 - 11.30	11.25 - 11.90
10"OS	11.00 - 12.25	11.00 - 11.65	11.60 - 12.25
12"	12.70 - 13.80	12.70 - 13.30	13.25 - 13.80
12"OS	13.15 - 14.40	13.15 - 13.80	13.75 - 14.40

Note: 4" - 8" 305 PSI Working Pressure  
10" & 12" 200 PSI Working Pressure

*Angular Deflection up to 7*

*Bolt Torque limit for 5/8" bolts is 80 ft./lbs.*

*All gaskets are NBR*

*A torque wrench should be used to ensure that the gaskets are sufficiently compressed*

*The use of a pipe insert is required when using on HDPE*

***Coupling is fully assembled with both gaskets when shipped***

***Couplings do not prevent Pipe Pullout. Restraint should be used where required***

#### ROBAR INDUSTRIES LTD.

BC Phone (604) 591-8811 / 1-800-663-6553

Fax (604) 591-5288

Email: [waterworks@robarindustries.com](mailto:waterworks@robarindustries.com)

#### LES PRODUITS INDUSTRIELS ROBAR INC.

QUEBEC

Phone (450) 441-7525 / 1-800-315-9525

Fax (450) 441-4894

Web: [www.robarindustries.com](http://www.robarindustries.com)





# The VANTAGE COUPLING

## 1498/1496/1598/1596/1696

PRICING INFORMATION

### MULTI-RANGE COUPLINGS

Nominal Size	Weight Lbs.	LIST PRICE			
		1498	1496	1598	1596
		Shop Coat MS Bolts & Nuts	Shop Coat SS Bolts & Nuts	Epoxy Coated MS Bolts & Nuts	Epoxy Coated SS Bolts & Nuts
4"	25	\$ 285.20	\$ 328.10	\$ 319.69	\$ 373.94
6"	32	\$ 375.22	\$ 415.59	\$ 410.55	\$ 454.71
8"	41	\$ 442.50	\$ 479.54	\$ 479.54	\$ 547.67
10"	75	\$ 647.78	\$ 707.53	\$ 698.25	\$ 783.23
12"	107	\$ 833.73	\$ 904.38	\$ 968.31	\$ 1,035.18

Nominal Size	Weight Lbs.	LIST PRICE
		1696
		All Stainless Steel
4"	25	\$ 695.14
6"	32	\$ 943.06
8"	41	\$ 1,390.74
10"	75	\$ 2,015.07
12"	107	\$ 2,372.96

The Vantage Working Range	Barrel Length	# of Bolts	
4"	4.50 - 5.60	8"	3
6"	6.63 - 7.60	8"	3
8"	8.63 - 9.80	8"	3
10"	10.75 - 12.26	12"	4
12"	12.75 - 14.40	12"	5

Note: 150 PSI Working Pressure  
 Angular Deflection up to 7 degrees  
 Bolt Torque limit for 5/8" bolts is 70 ft./lbs.  
 All gaskets are NBR  
 A torque wrench should be used to ensure that the gaskets are sufficiently compressed  
**Couplings do not prevent Pipe Pullout. Restraint should be used where required**

#### ROBAR INDUSTRIES LTD.

BC Phone (604) 591-8811 / 1-800-663-6553  
 Fax (604) 591-5288  
 Email: waterworks@robarindustries.com

#### LES PRODUITS INDUSTRIELS ROBAR INC.

QUEBEC Phone (450) 441-7525 / 1-800-315-9525  
 Fax (450) 441-4894  
 Web www.Robarindustries.com

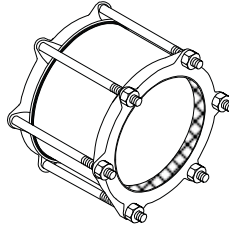

Nominal Size	Weight Lbs	LIST PRICE					
		1408	1406	1506	1508	1519	1507
4" STD	16.0	\$ 149.84	\$ 214.33	\$ 267.71	\$ 202.70	\$ 233.28	\$ 303.84
4" LB	21.0	\$ 172.31	\$ 246.47	\$ 307.70	\$ 233.09	\$ 267.03	\$ 352.43
6"STD	24.0	\$ 215.76	\$ 295.97	\$ 379.78	\$ 282.01	\$ 334.96	\$ 424.96
6"LB	32.0	\$ 248.14	\$ 340.35	\$ 436.75	\$ 324.31	\$ 384.05	\$ 492.96
8"STD	28.0	\$ 275.68	\$ 371.59	\$ 476.62	\$ 356.08	\$ 430.01	\$ 530.79
8"LB	34.0	\$ 317.03	\$ 427.33	\$ 548.14	\$ 409.47	\$ 494.70	\$ 615.71
10"	49.0	\$ 421.22	\$ 537.39	\$ 673.44	\$ 521.05	\$ 603.91	\$ 732.63
12"	56.0	\$ 501.01	\$ 642.88	\$ 796.86	\$ 648.14	\$ 711.01	\$ 869.02

STD= 5" center barrel

LB = 7" center barrel

The Stab Fit Working Range		# of Bolts	Barrel Length
4"	4.50 - 5.10"	4	5" or 7"
6"	6.63 - 7.22"	4	5" or 7"
8"	8.63 - 9.30"	5	5" or 7"
10"	10.75 - 11.40"	7	7"
12"	12.75 - 13.50"	7	7"

Notes: Couplings fits IPS OD to old cast OD with one gasket  
 Does not require dis-assembly to install  
 One less bolt compared to conventional bolted coupling  
 An economical alternative to typical wide range couplings  
 Rugged cast ductile construction

***Couplings do not prevent Pipe Pullout. Restraint should be used where required***

## ROBAR INDUSTRIES LTD.

BC Phone (604) 591-8811 / 1-800-663-6553  
 Fax (604) 591-5288  
 Email: waterworks@robarindustries.com

## LES PRODUITS INDUSTRIELS ROBAR INC.

QUEBEC Phone (450) 441-7525 / 1-800-315-9525  
 Fax (450) 441-4894  
 Web: www.Robarindustries.com



# EBAA 3800 SERIES COUPLINGS

## PRICING INFORMATION

The 3800 Restrained Coupling is used for joining and restraining two plain end pipes of the same or dissimilar materials (Ductile Iron, Steel, PVC C900, and HDPE).

### EBAA 3800 Restrained Coupling

Nominal Size	Weight Lbs.	LIST PRICE			
		STANDARD (C900 or DI Pipe)	Transition (STD x IPS)	IPS x IPS	Add on for SS Tie Rods
4"	37	\$ 389.62	\$ 407.46	\$ 425.30	\$ 137.96
6"	50	\$ 523.86	\$ 546.52	\$ 569.17	\$ 208.04
8"	68	\$ 680.10	\$ 712.44	\$ 744.78	\$ 208.04
10"	86	\$ 902.16	\$ 952.15	\$ 1,002.14	\$ 275.92
12"	104	\$ 1,030.64	\$ 1,094.16	\$ 1,157.68	\$ 275.92

For larger sizes please contact Robar

Note: *Up to 350 PSI Working Pressure*  
*The use of a pipe wall stiffening insert (model 9626) is required for use on HDPE*  
*Angular Deflection up to 5 degrees*  
*3/4" Diameter Tie Rods*  
*Torque limiting twist off nuts*  
*All gaskets are SBR. Other compounds available*  
*Couplings are made of cast ductile iron*  
*Minimum 2 to 1 safety factor*

#### ROBAR INDUSTRIES LTD.

**BC** Phone (604) 591-8811 / 1-800-663-6553  
 Fax (604) 591-5288  
 Email: waterworks@robarindustries.com

#### LES PRODUITS INDUSTRIELS ROBAR INC.

**QUEBEC** Phone (450) 441-7525 / 1-800-315-9525  
 Fax (450) 441-4894  
 Web: www.Robarindustries.com



# 1180 ISOLATING BOOTS

## PRICE INFORMATION

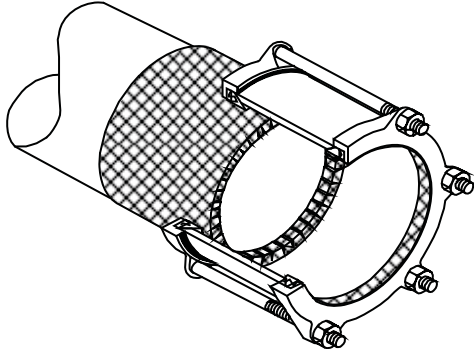
**Standard Sizes:**

4" to 24" Nominal Pipe OD  
Larger Sizes are available

**USE:**

Robar 1180 Isolating boot are used in conjunction with ROBAR couplings to separate pipe ends in cathodically protected areas.  
Gasket length is 7"

**Material Specification:**

**Boot:** NBR (Buna N) Rubber Compound for water service and high dielectric value.  
(ASTM D2000-80 AA 615).

Nominal Pipe Size		LIST PRICE
4		\$ 49.91
6		\$ 66.78
8		\$ 80.40
10		\$ 120.47
12		\$ 134.69
14		\$ 154.19
16		\$ 177.43
18		\$ 193.35
20		\$ 216.28
22		\$ 241.93
24		\$ 257.81

**ROBAR INDUSTRIES LTD.**

**BC** Phone (604) 591-8811 / 1-800-663-6553  
Fax (604) 591-5288  
Email: waterworks@robarindustries.com

**LES PRODUITS INDUSTRIELS ROBAR INC.**

**QUEBEC** Phone (450) 441-7525 / 1-800-315-9525  
Fax (450) 441-4894  
Web: www.Robarindustries.com



# 1410 & 1510 COUPLING END CAPS

## PRICE INFORMATION

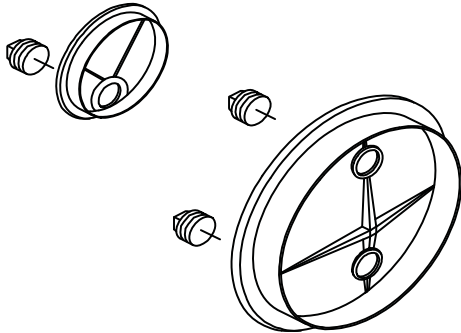

### Standard Sizes:

4" to 10" Nominal Pipe OD

### USE:

Robar 1410 & 1510 End Caps are used in conjunction with a standard ROBAR coupling (ordered separately) for the purpose of: Temporary stops for mains to be extended in the future

### MATERIAL SPECIFICATION

CAP: Cast Ductile Iron (ASTM A536)  
 PLUG: Cast Iron - 2"IP square head  
 COATING: 1410 - two coats of Enamel  
 1510 - Corrosion Protective Epoxy Coated (AWWA C-213).

For an enamel coated 8" End Cap, the ordering code is:  
1410 - 8"

Nominal Pipe Size	Cap OD	Outlet Plug Quantity	LIST PRICE	
			1410	1510
4	5.1	1	\$ 86.59	\$ 102.32
6	7.1	1	\$ 96.96	\$ 113.23
8	9.3	1	\$ 129.82	\$ 149.34
10	11.4	2	\$ 194.36	\$ 223.09

Note: End capped coupling must be restrained to resist hydraulic end thrust

### ROBAR INDUSTRIES LTD.

BC Phone (604) 591-8811 / 1-800-663-6553  
 Fax (604) 591-5288  
 Email: waterworks@robarindustries.com

### LES PRODUITS INDUSTRIELS ROBAR INC.

QUEBEC Phone (450) 441-7525 / 1-800-315-9525  
 Fax (450) 441-4894  
 Web: www.Robarindustries.com



# 1606 STAINLESS STEEL COUPLINGS

## PRICE INFORMATION

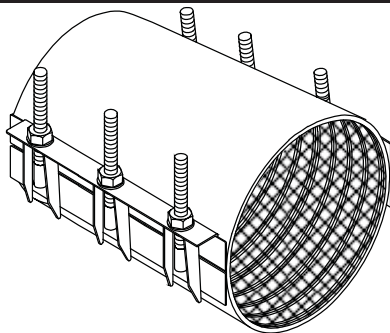

Nominal Pipe Size	Maximum Pressure (PSI)	LIST PRICE				
		Style 1 6" Shell	Style 1 12" Shell	Style 2 12" Shell	Style 3 18" Shell	Style 3 24" Shell
4	150	\$ 176.89	\$ 320.75	\$ 516.57		
6	150	\$ 192.92	\$ 351.72	\$ 560.79		
8	150	\$ 227.13	\$ 377.06	\$ 597.82		
10	150		\$ 407.87	\$ 633.02		
12	150		\$ 463.42	\$ 673.81		
14	125		\$ 526.39	\$ 716.72		
16	100				\$ 1,431.89	\$ 1,817.94
18	100				\$ 1,507.81	\$ 1,910.55
20	100					\$ 2,127.04
22	100					\$ 2,197.69
24	100					\$ 2,273.05

Note: Other sizes and pressure ratings available  
 Bolt torque limit for all sizes is 80 ft/lbs  
 ROBAR 9626 Adjustable stainless steel Inserts are recommended for use on HDPE  
 4.80"OD is the minimum OD 1606 Couplings can be sized to fit

### ROBAR INDUSTRIES LTD.

BC Phone (604) 591-8811 / 1-800-663-6553  
 Fax (604) 591-5288  
 Email waterworks@robarindustries.com

### LES PRODUITS INDUSTRIELS ROBAR INC.

QUEBEC Phone (450) 441-7525 / 1-800-315-9525  
 Fax (450) 441-4894  
 Web: www.Robarindustries.com



# 1200 Series Galvanized Couplings

## PRICE INFORMATION

Nominal Pipe Size	Actual Pipe OD	Maximum Pressure (PSI)	LIST PRICE	
			QTY 1 - 49	QTY 50 - 149
1/2"	.84"	150	\$ 19.59	\$ 17.81
3/4"	1.05"	150	\$ 23.21	\$ 21.10
1"	1.32"	150	\$ 29.23	\$ 26.59
1-1/4"	1.66"	150	\$ 38.16	\$ 34.68
1-1/2"	1.90"	150	\$ 46.39	\$ 42.15
2"	2.38"	150	\$ 57.94	\$ 52.66

Note: Gaskets are made from Nitrile Rubber (NBR) compound.  
Galvanized finish for corrosion resistance  
non-restrained connection between pipes of the same diameter

### ROBAR INDUSTRIES LTD.

**BC** Phone (604) 591-8811 / 1-800-663-6553  
Fax (604) 591-5288  
Email: [waterworks@robarindustries.com](mailto:waterworks@robarindustries.com)

### LES PRODUITS INDUSTRIELS ROBAR INC.

**QUEBEC** Phone (450) 441-7525 / 1-800-315-9525  
Fax (450) 441-4894  
Web [www.Robarindustries.com](http://www.Robarindustries.com)