

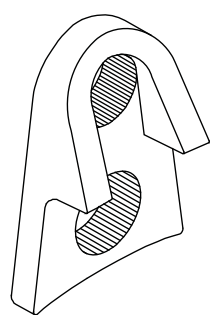

4499 RESTRAINT LUG

CAST DUCTILE IRON
PRICE INFORMATION



SIZES AVAILABLE:
One Size only.

USE:
ROBAR 4499 Restraint Lugs are designed for use on Mechanical Joint Fittings to prevent pipe pull-out.

Material: Cast Ductile Iron (ASTM A536)

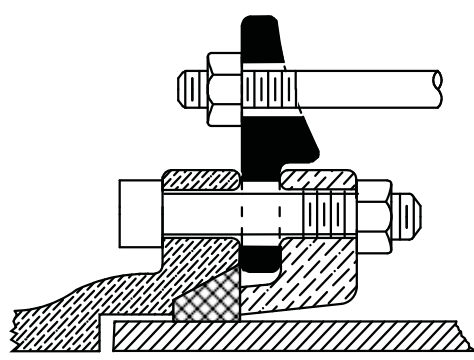
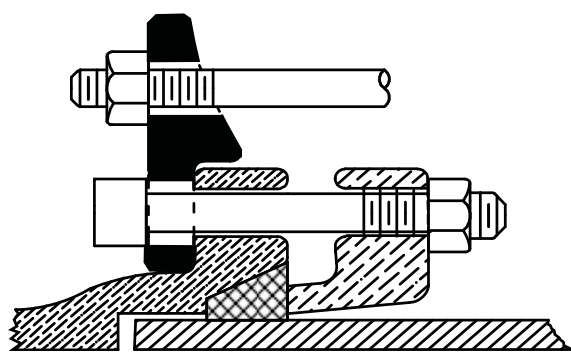

Robar Product No.	LIST PRICE
4499	\$ 11.75

ROBAR INDUSTRIES LTD.
BC Phone (604) 591-8811 / 1-800-663-6553
 Fax (604) 591-5288
 Email: waterworks@robarindustries.com

LES PRODUITS INDUSTRIELS ROBAR INC.
QUEBEC Phone (450) 441-7525 / 1-800-315-9525
 Fax (450) 441-4894
 Web: www.Robarindustries.com